



www.flitetest.com

# FT Mini Charlie

Designed By: Kenny Le  
Drawing By: Dan Sponholz



## SPECIFICATIONS

DESCRIPTION		IMPERIAL	METRIC
LENGTH		27.8 in	705 mm
CENTER OF GRAVITY (FROM NOSE)	CG	14 in	355 mm
WING SPAN		28 in	711 mm
WING AREA		156.2 in <sup>2</sup>	10.1 dm <sup>2</sup>
DRY WEIGHT		8.1 oz	230 g
ALL UP WEIGHT	AUW	10.4 oz	295 g
WING LOADING	WL	9.6 oz/ft <sup>2</sup>	29.2 g/dm <sup>2</sup>
WING CUBIC LOADING	WCL	9.2	

## RECOMMENDED SETTINGS

	THROW	EXPO
ELEVONS	16°	30%

Build Skill Level :



Pilot Skill Level :



## SHEET & TILE KEY



1	2	3	4
5	6	7	8

9	10	11	12
13	14	15	16

17	18	19	20
21	22	23	24

© 2016 Flite Test, LLC. Plans provided free of charge. Copies allowed for personal use only. Not for commercial use.

Template Version 3.0.1

# DRAWING KEY

## FOLD TYPES

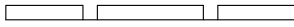
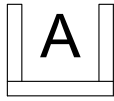

A - FOLD (ABOVE)

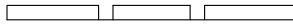
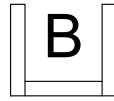
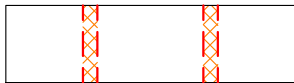

B - FOLD (BESIDE)

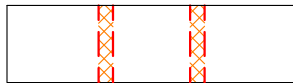

C

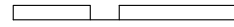
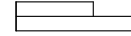

C - FOLD (COVER)

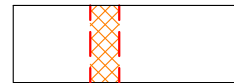

## LINE TYPE/COLOR

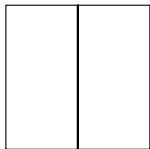

CUT

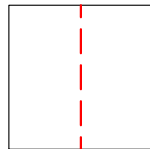

50% SCORE

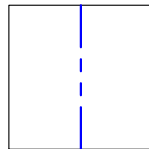
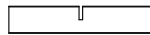

CREASE

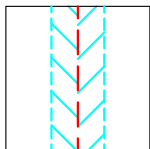
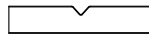

45° DOUBLE  
BEVEL

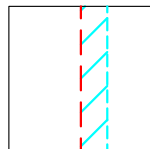
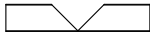

45° SINGLE  
BEVEL

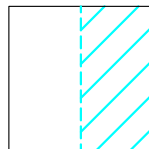
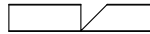

EDGE  
BEVEL

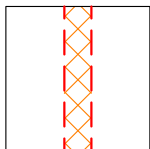
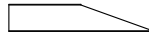

CAVITY



REMOVE  
PAPER

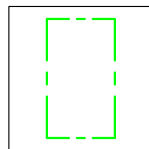
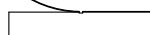

REFERENCE/  
OPTIONAL

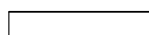

## SYMBOLS

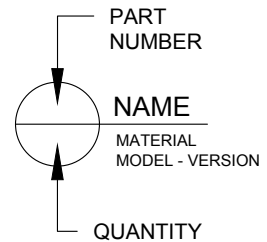

DOWEL  
HOLE



CENTER  
OF  
GRAVITY  
(CG)

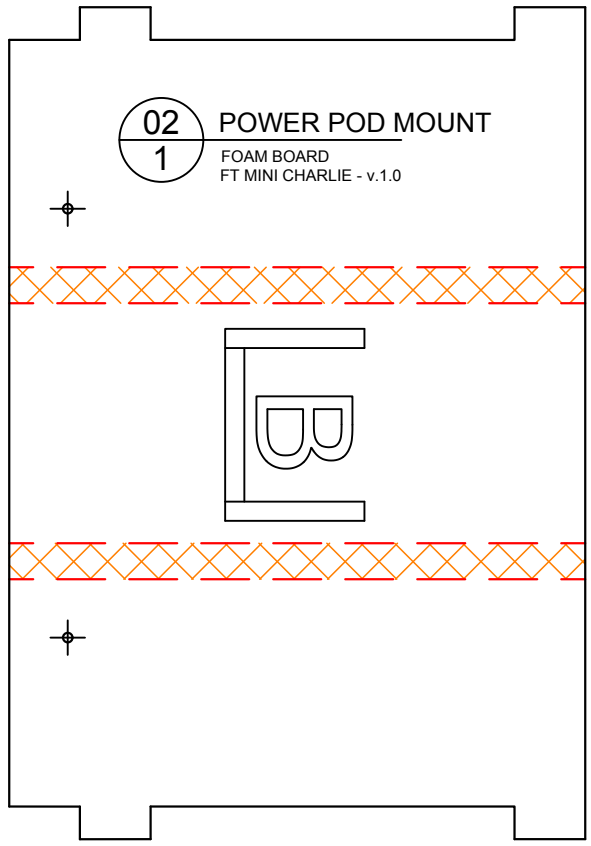
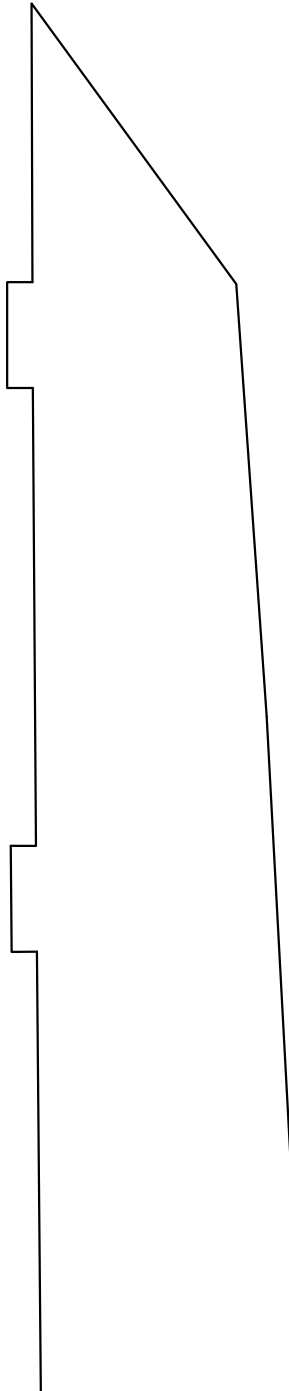

**02** POWER POD MOUNT  
**1** FOAM BOARD  
FT MINI CHARLIE - v.1.0



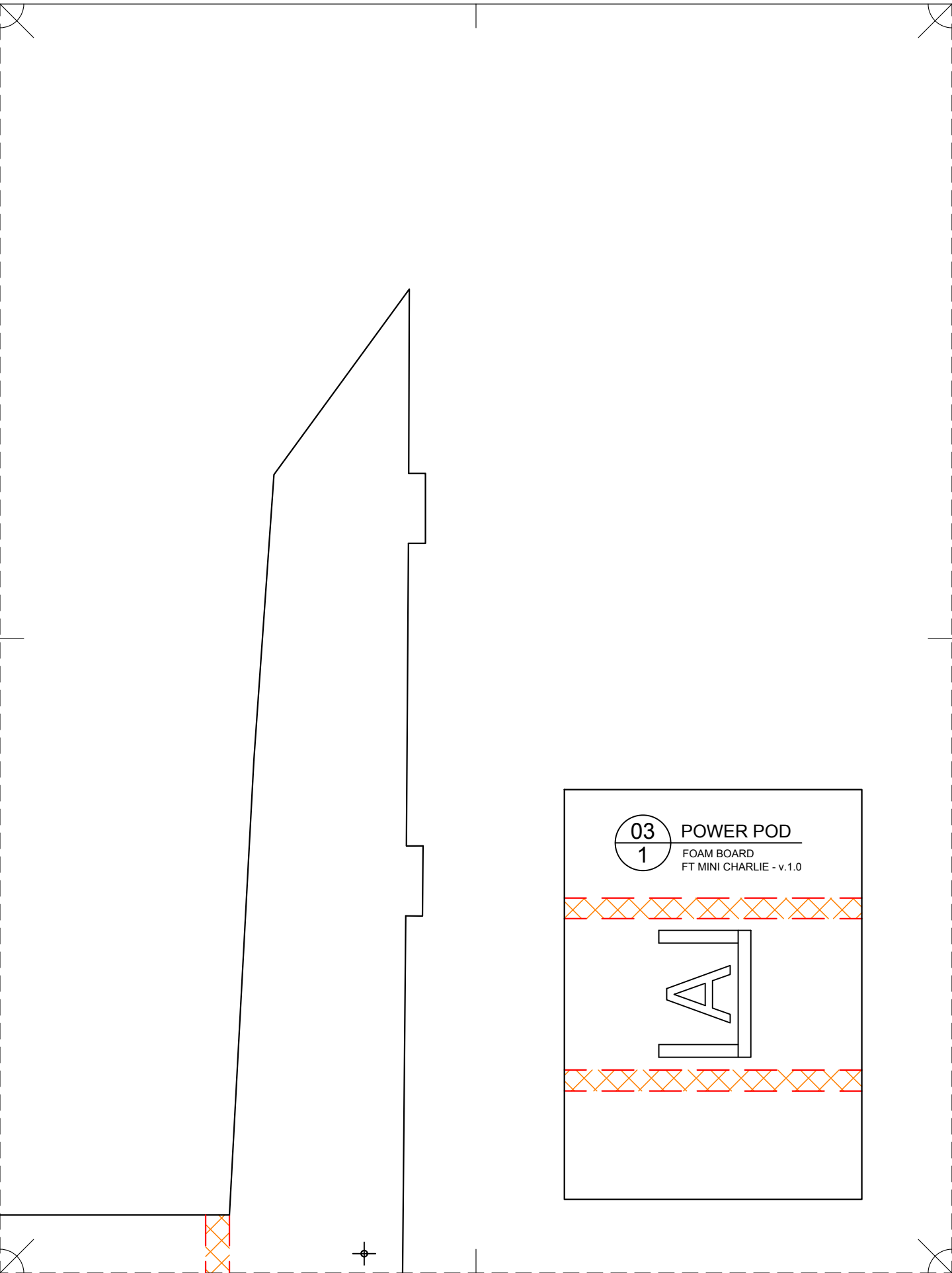

03  
1

**POWER POD**

FOAM BOARD  
FT MINI CHARLIE - v.1.0

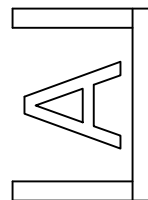

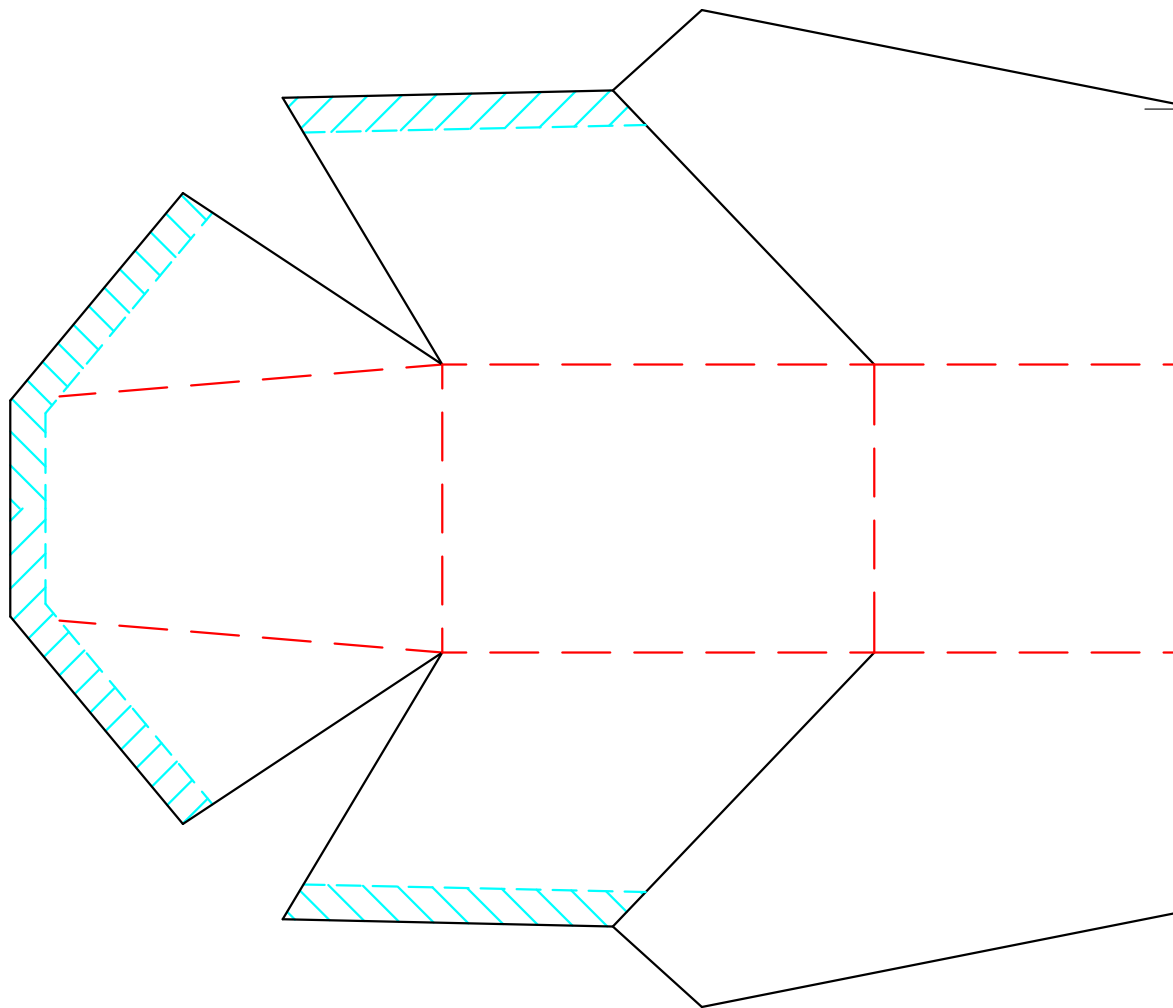
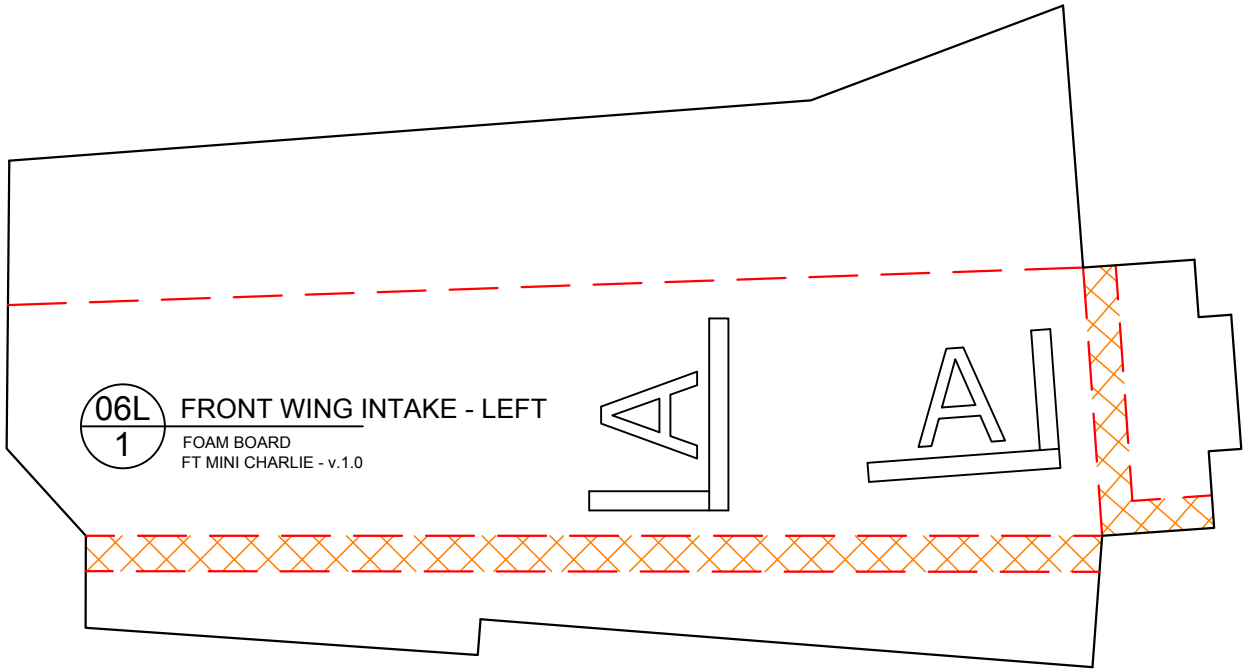

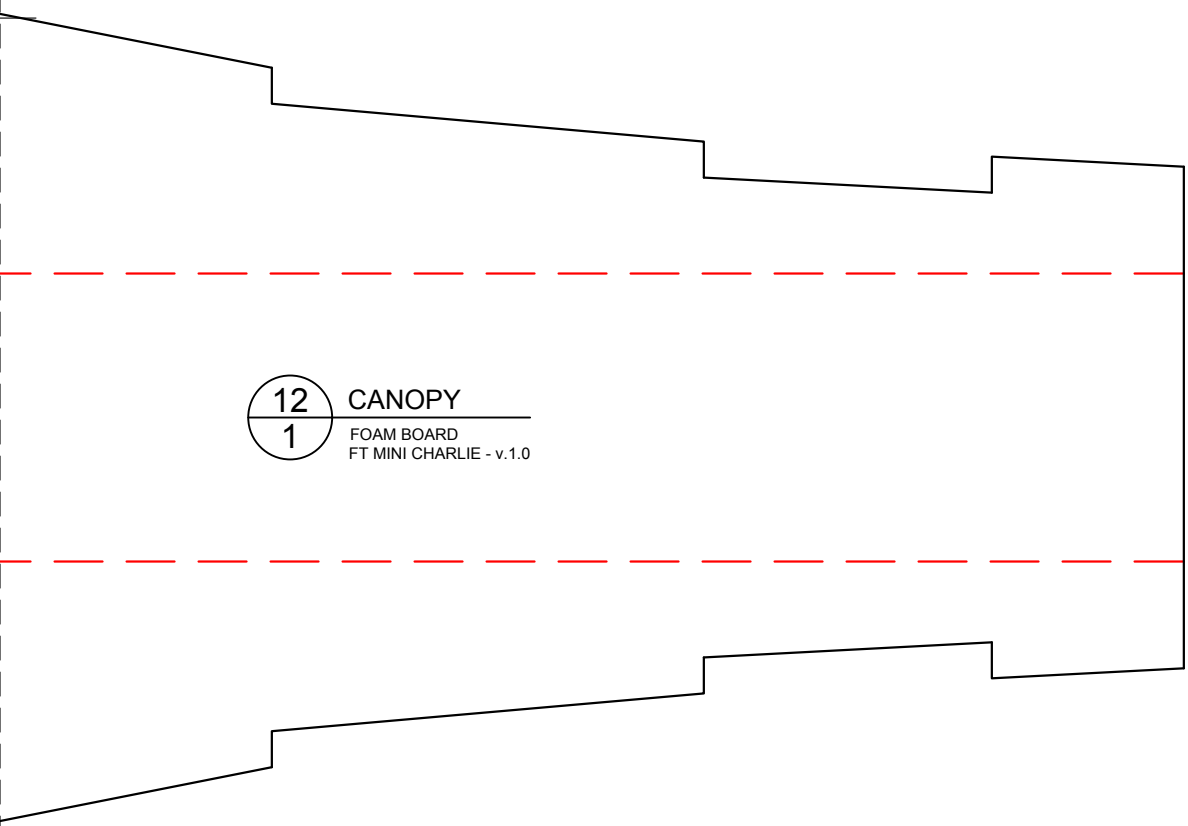
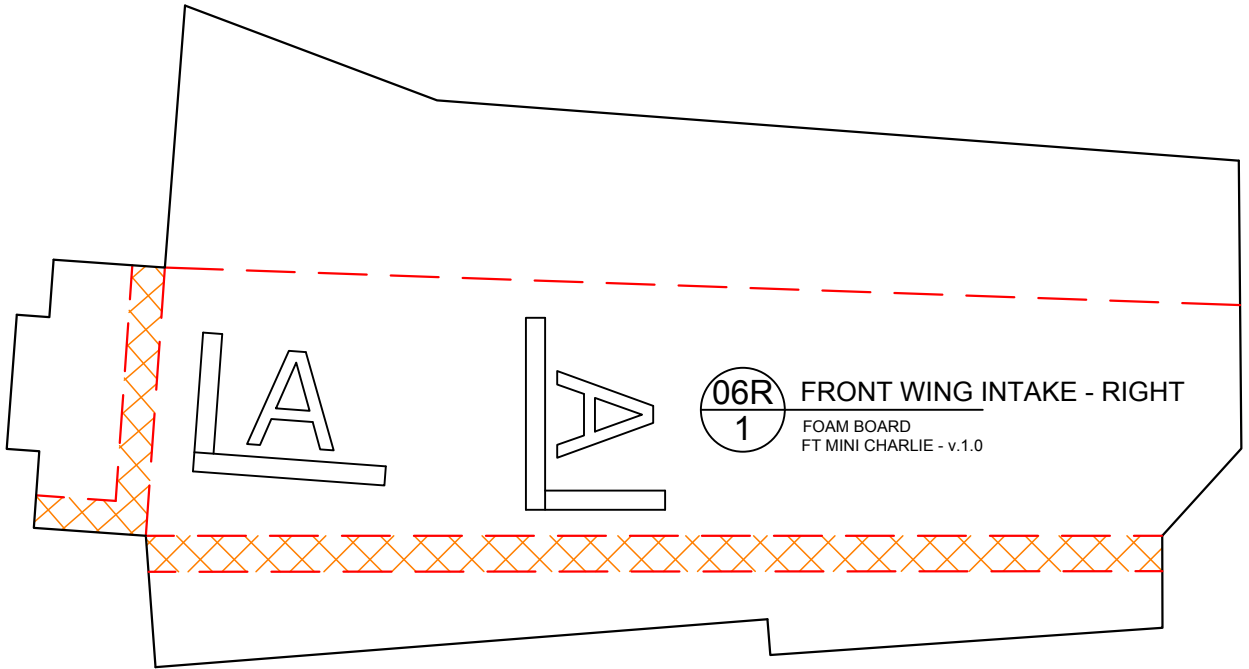

01 BELLY PAN  
FOAM BOARD  
FT MINI CHARLIE - v.1.0

B

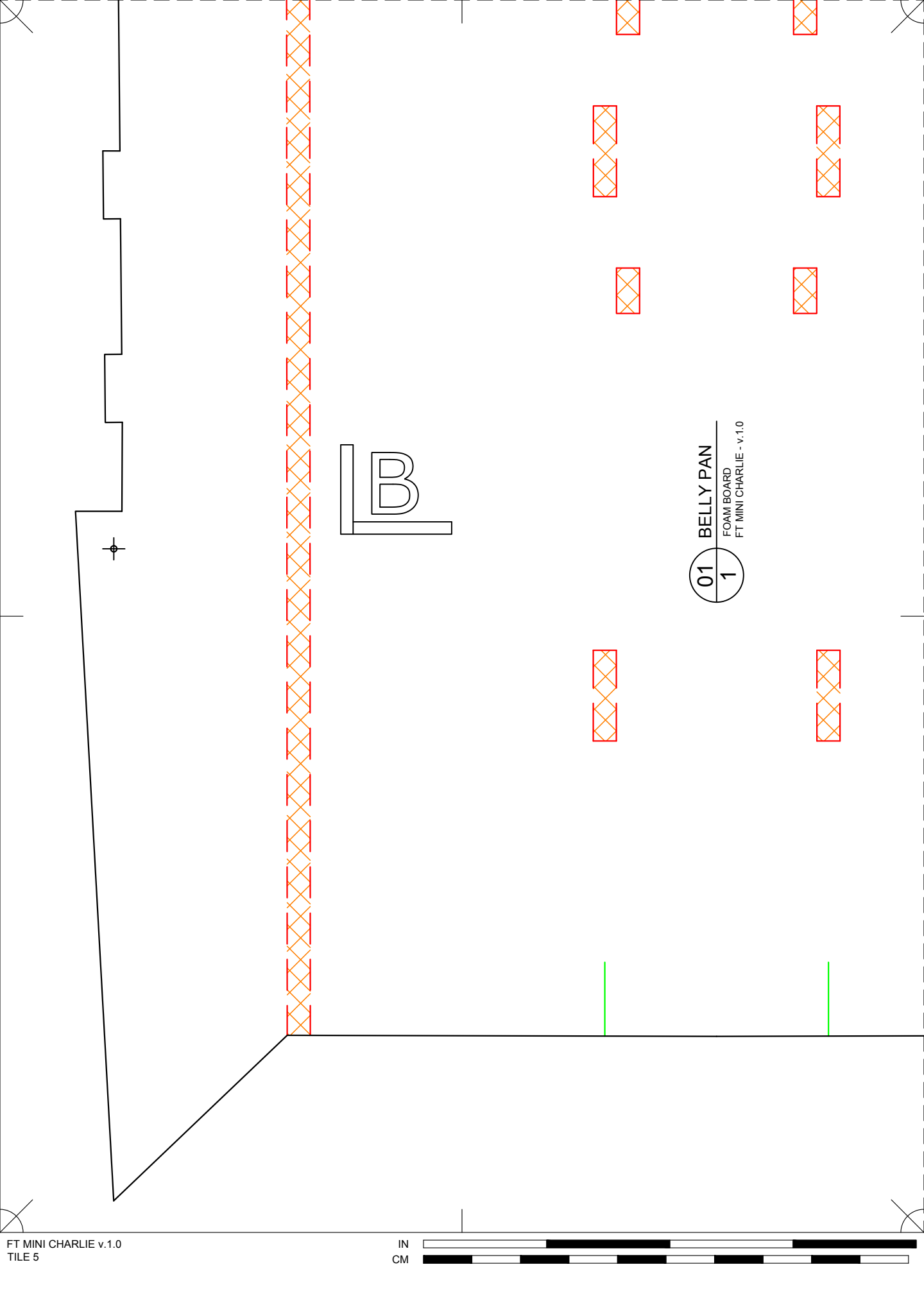

B

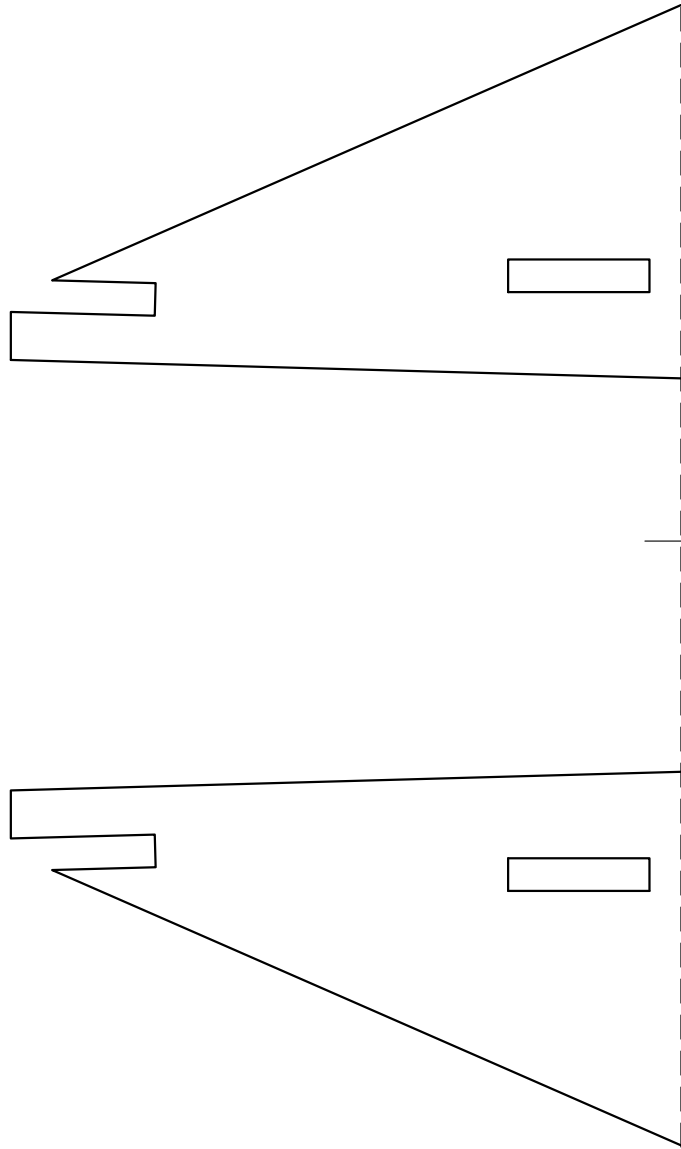



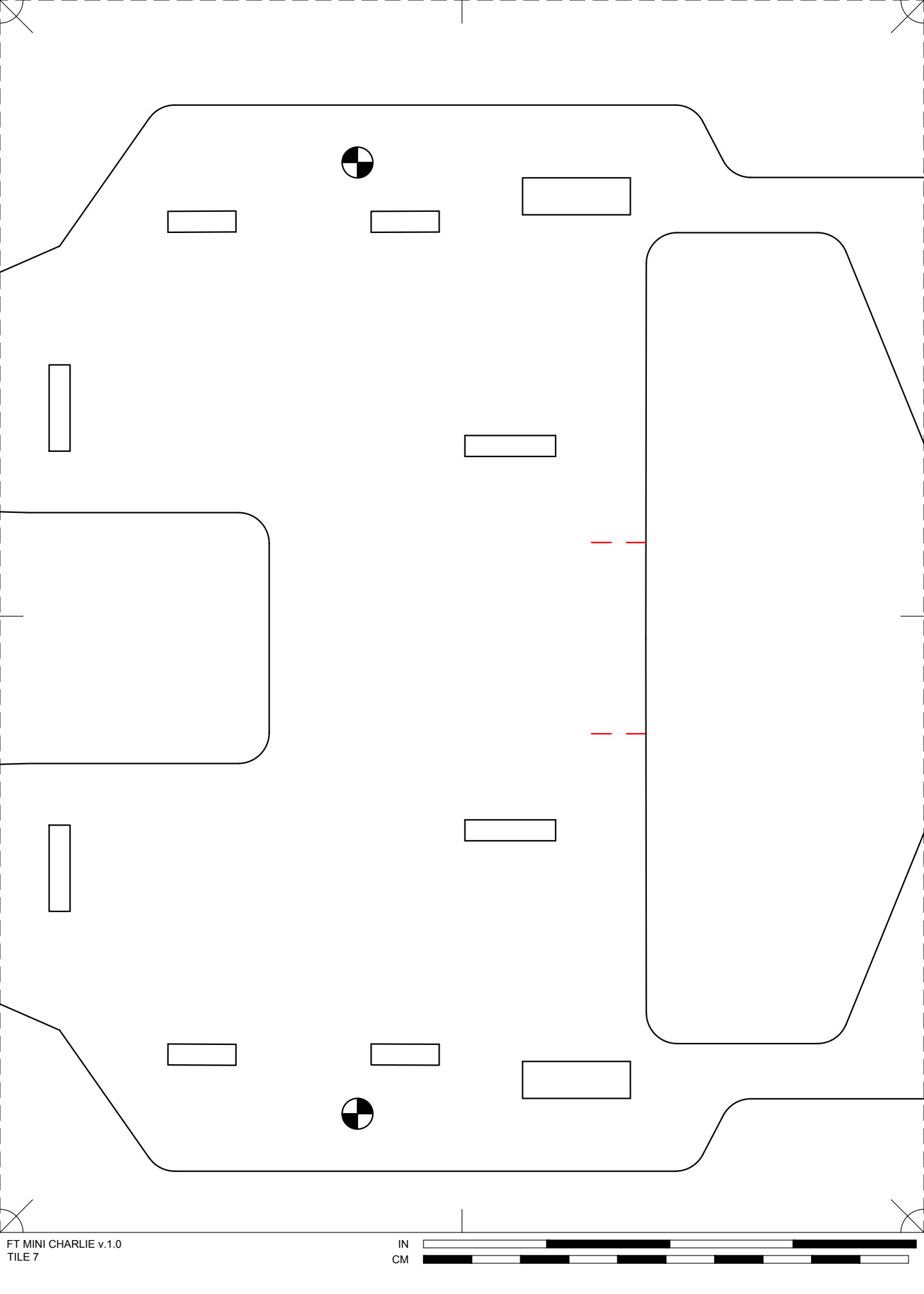

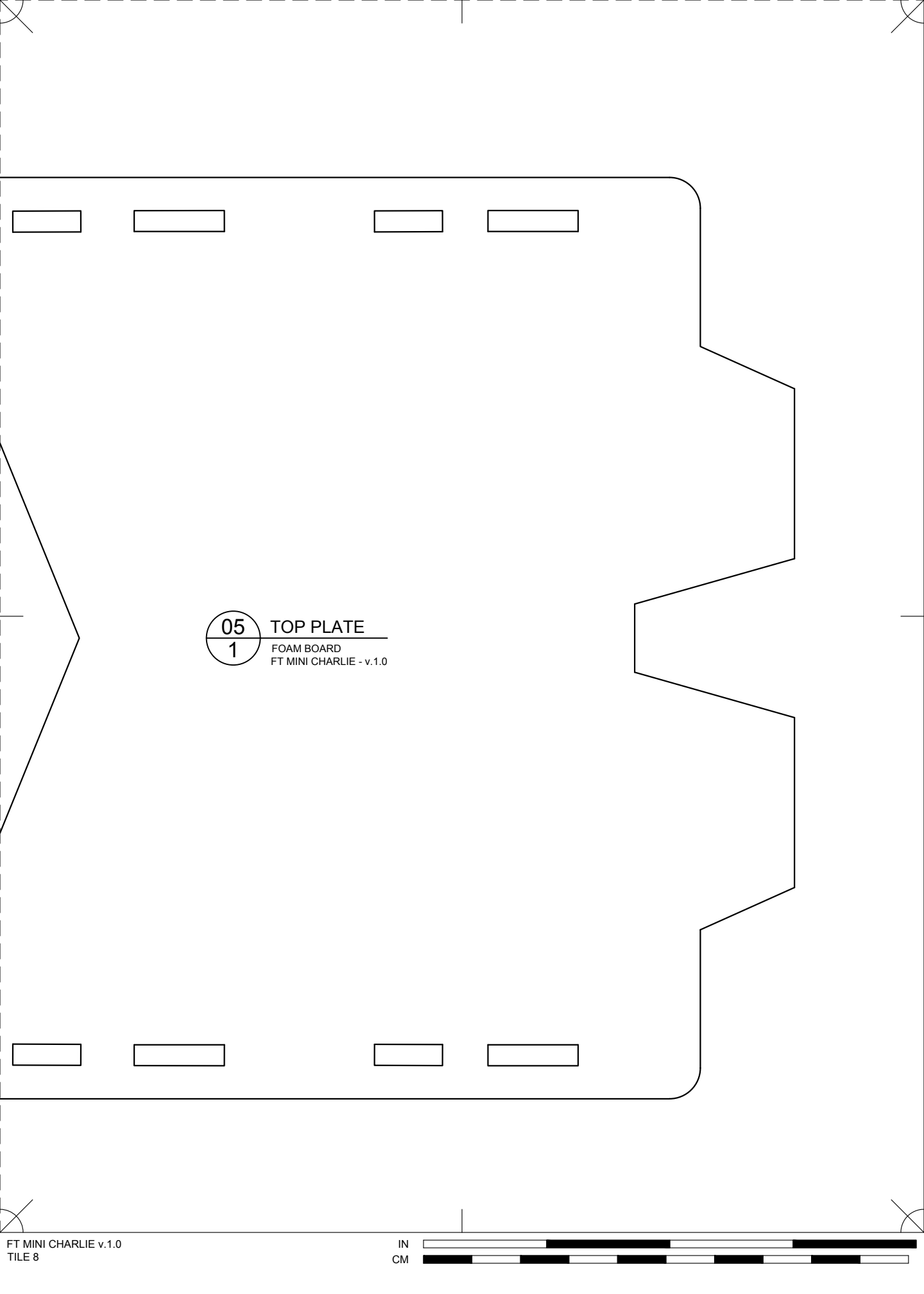

05  
1

TOP PLATE  
FOAM BOARD  
FT MINI CHARLIE - v.1.0

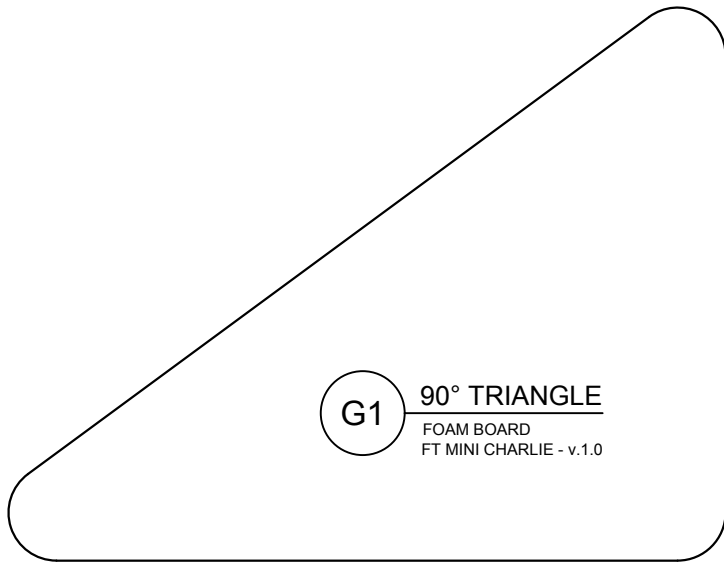

G1 90° TRIANGLE  
FOAM BOARD  
FT MINI CHARLIE - v.1.0

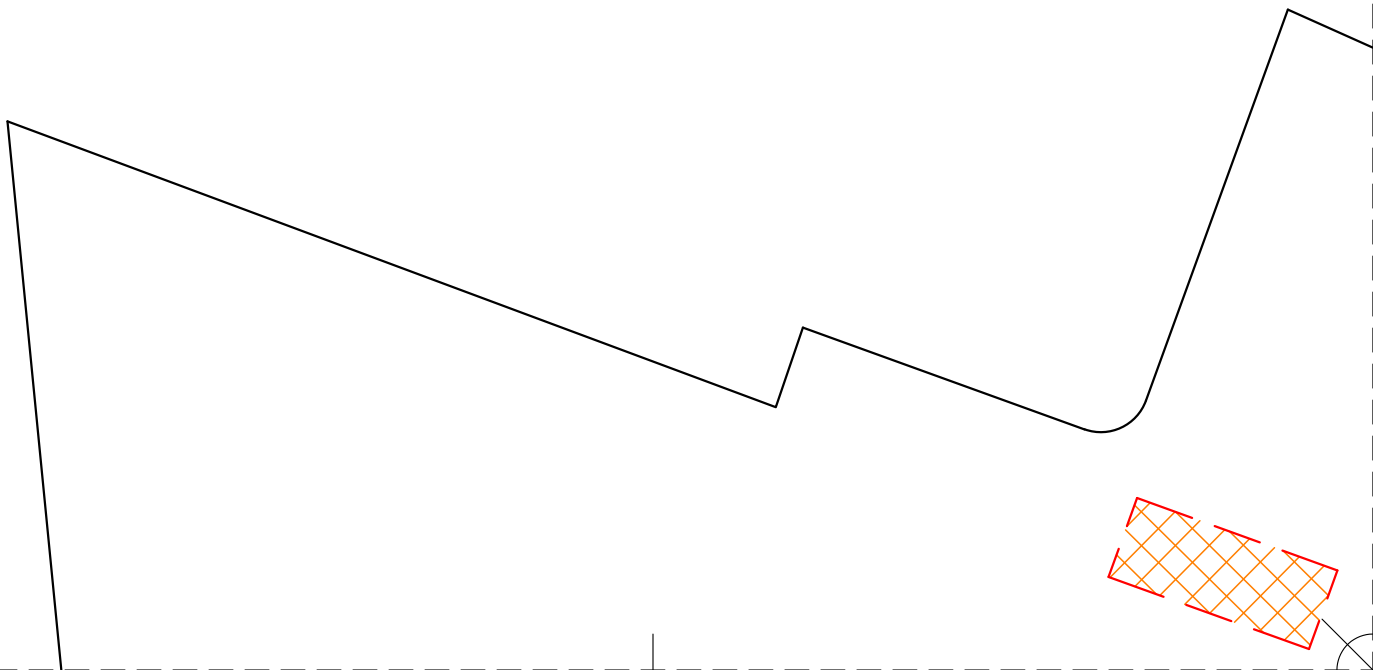

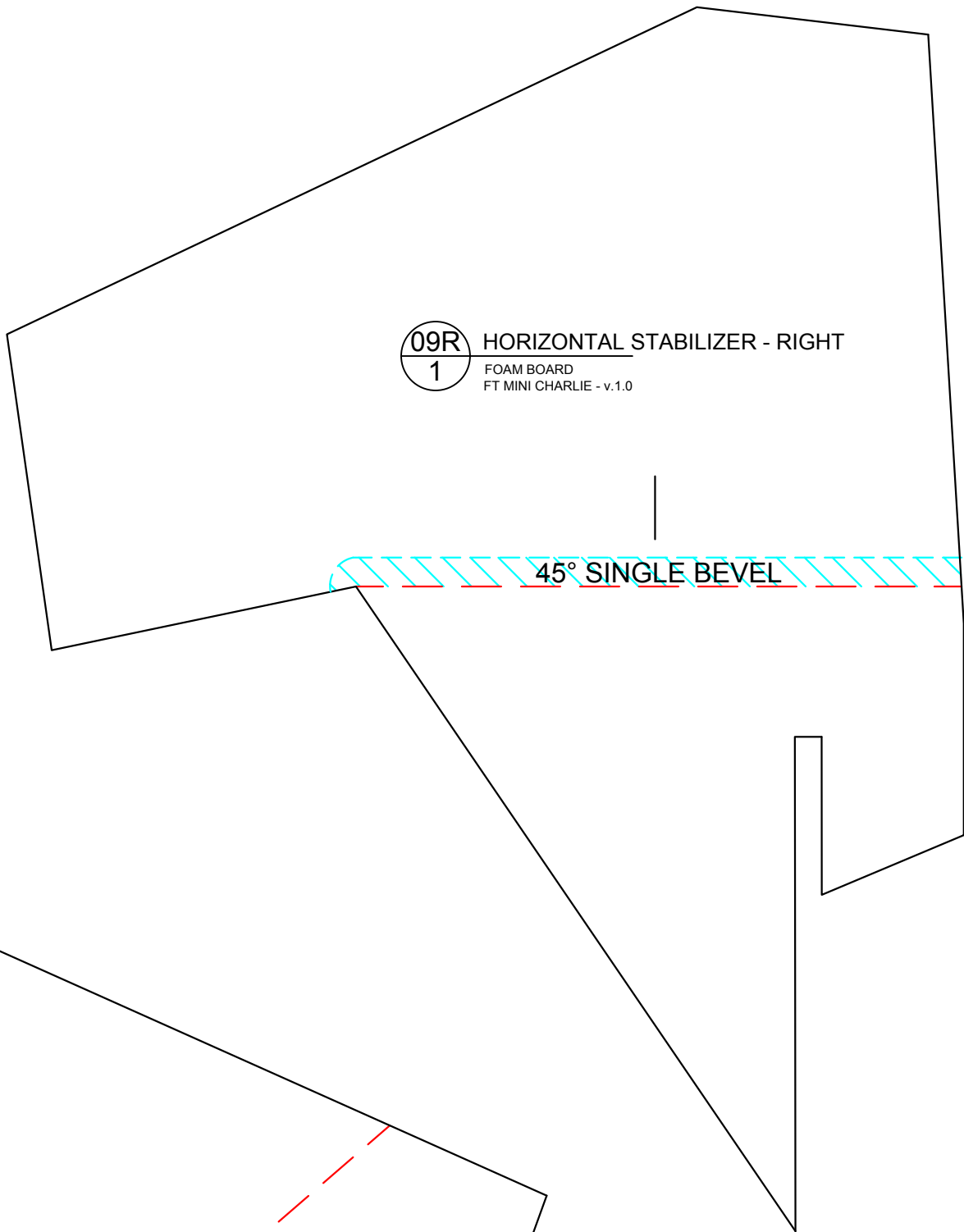

09R  
1

HORIZONTAL STABILIZER - RIGHT

FOAM BOARD  
FT MINI CHARLIE - v.1.0

45° SINGLE BEVEL

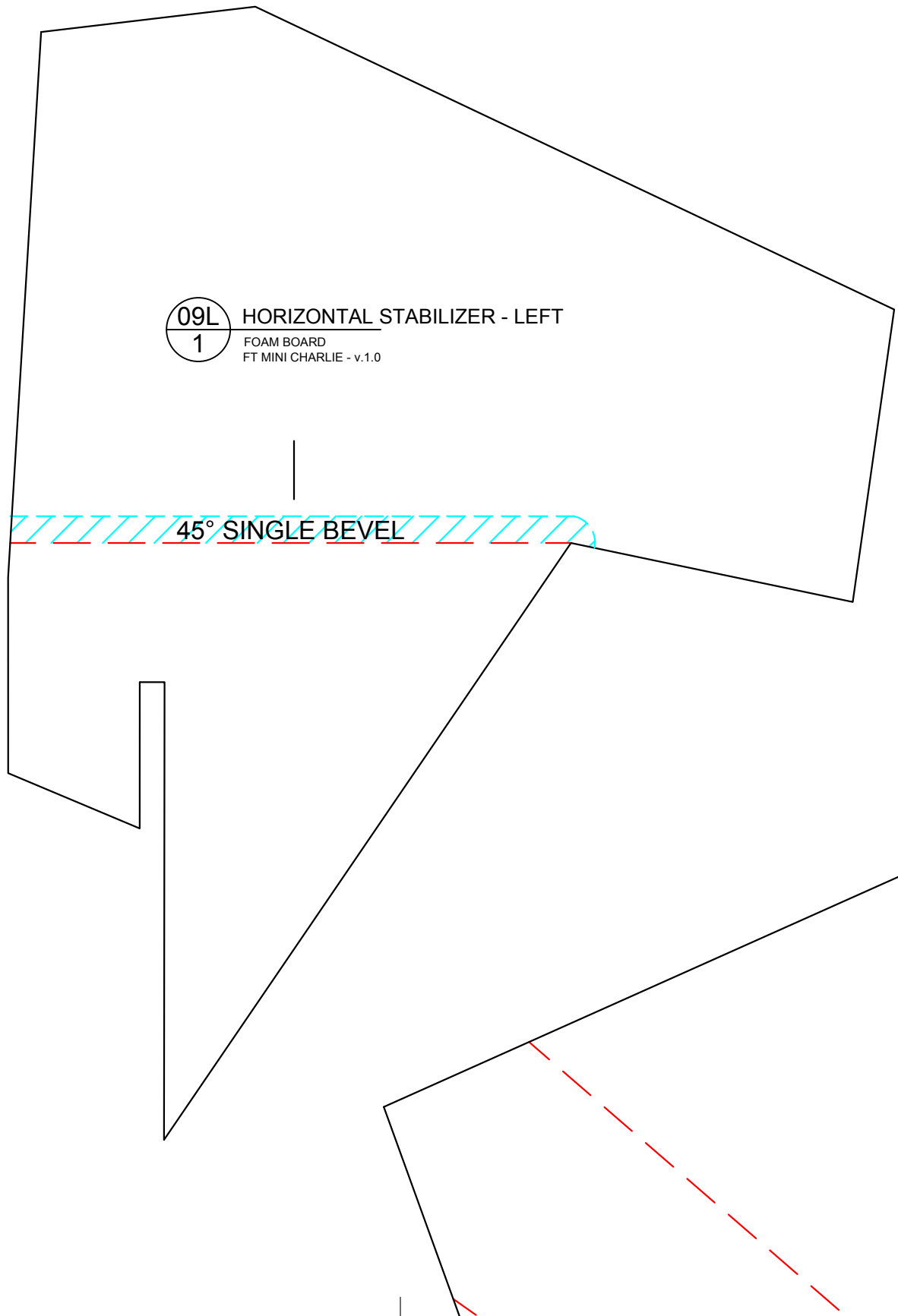

09L  
1

HORIZONTAL STABILIZER - LEFT

FOAM BOARD  
FT MINI CHARLIE - v.1.0

45° SINGLE BEVEL

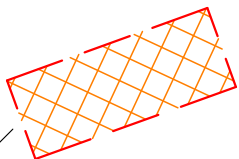
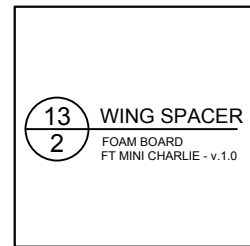
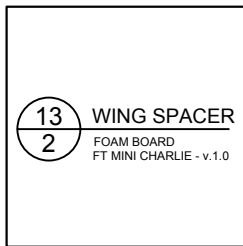

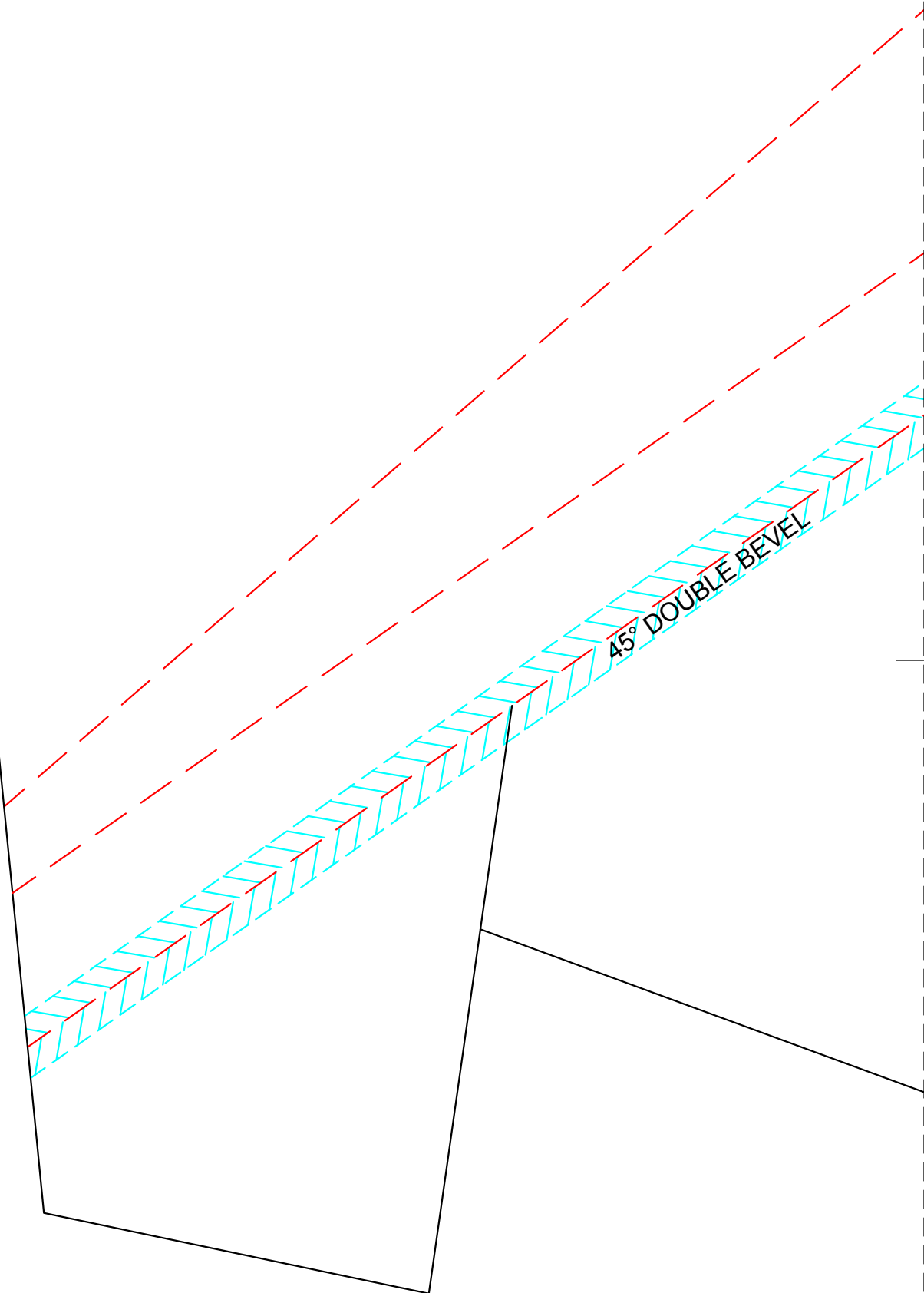

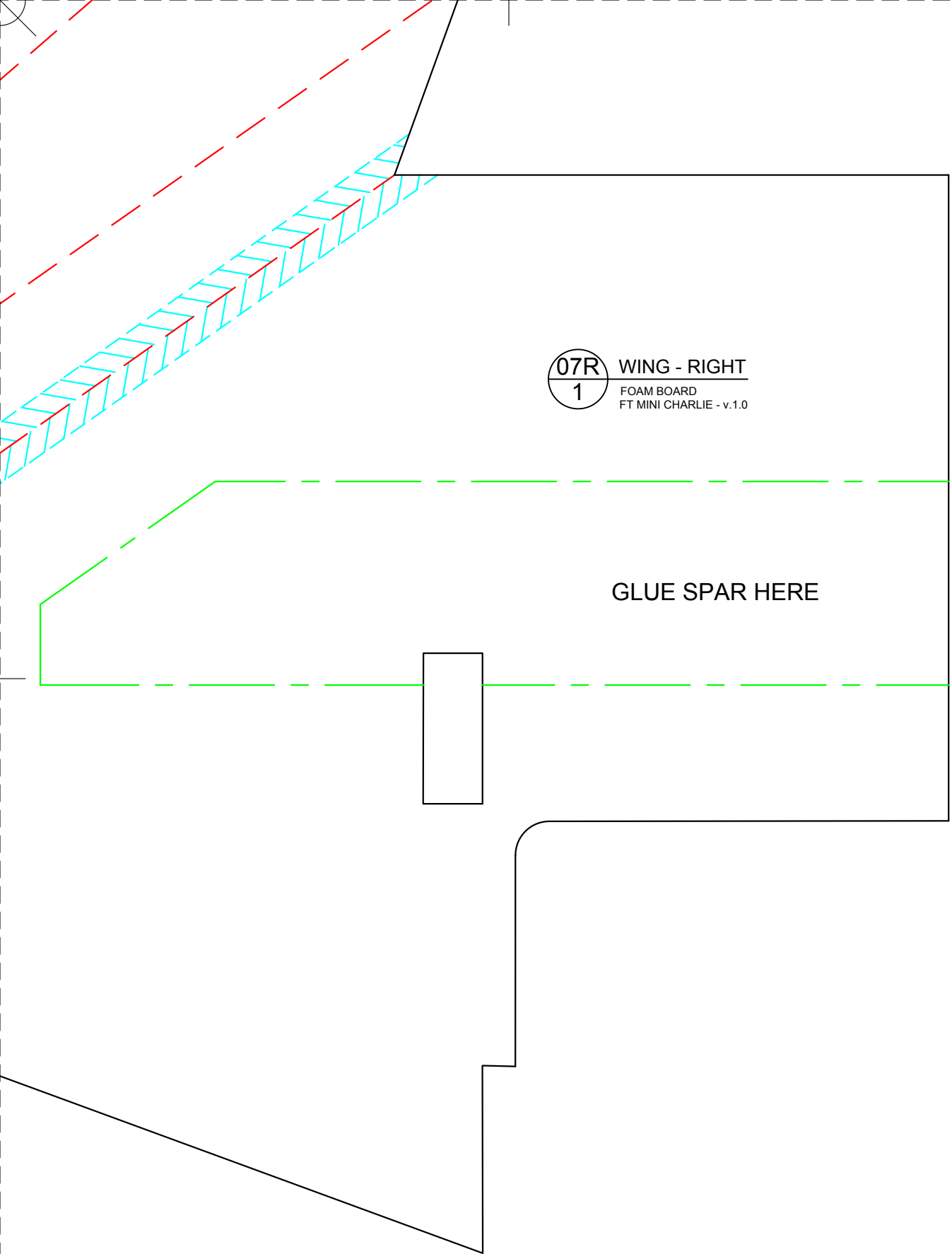

**07R** WING - RIGHT  
1 FOAM BOARD  
FT MINI CHARLIE - v.1.0

GLUE SPAR HERE



07L  
1

WING - LEFT  
FOAM BOARD  
FT MINI CHARLIE - v.1.0

GLUE SPAR HERE

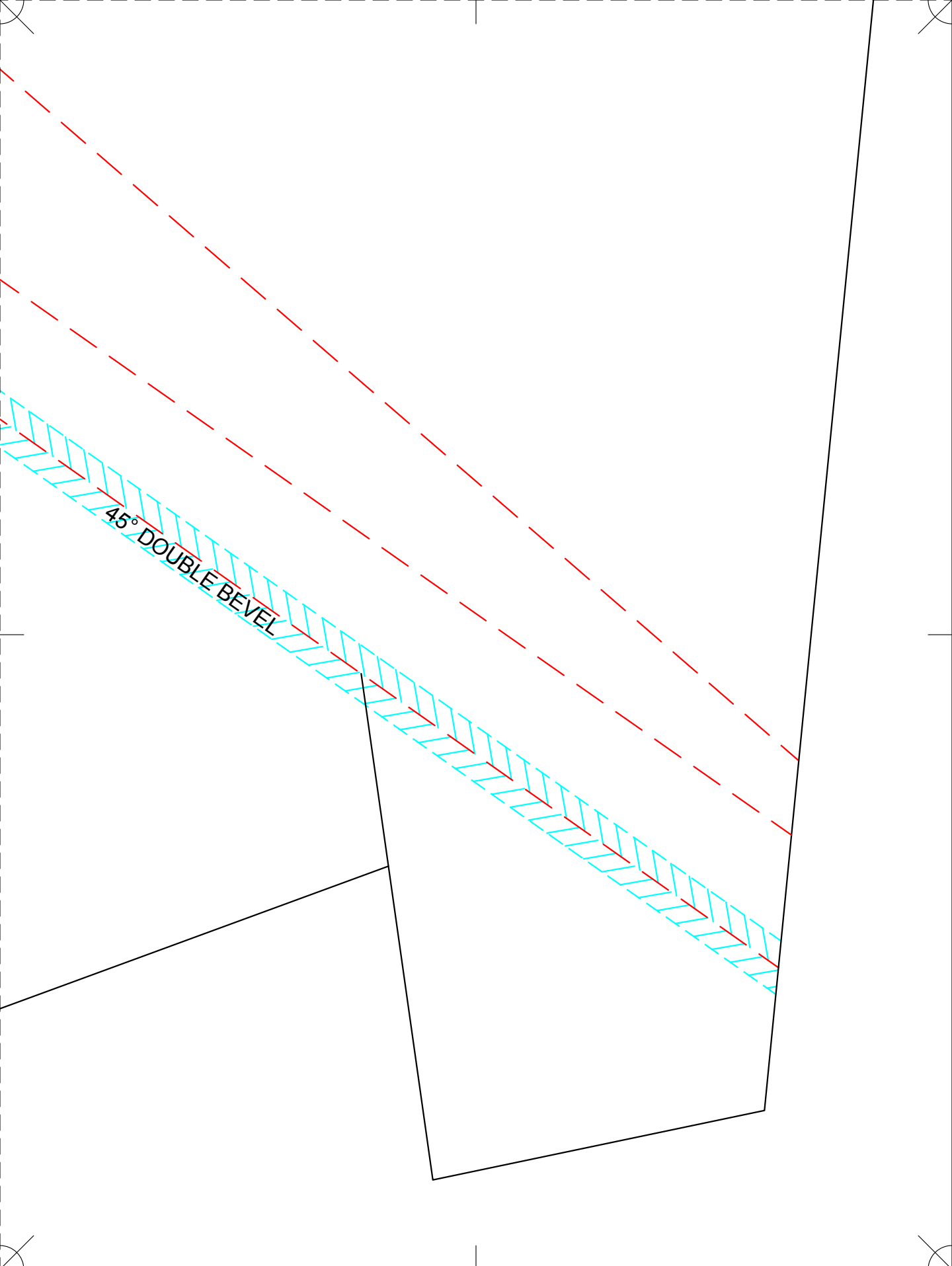

45° DOUBLE BEVEL

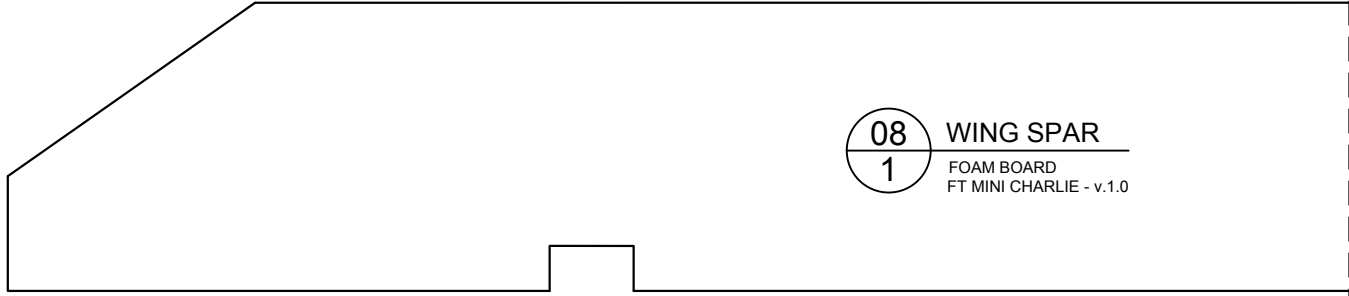

**08** WING SPAR  
**1** FOAM BOARD  
FT MINI CHARLIE - v.1.0

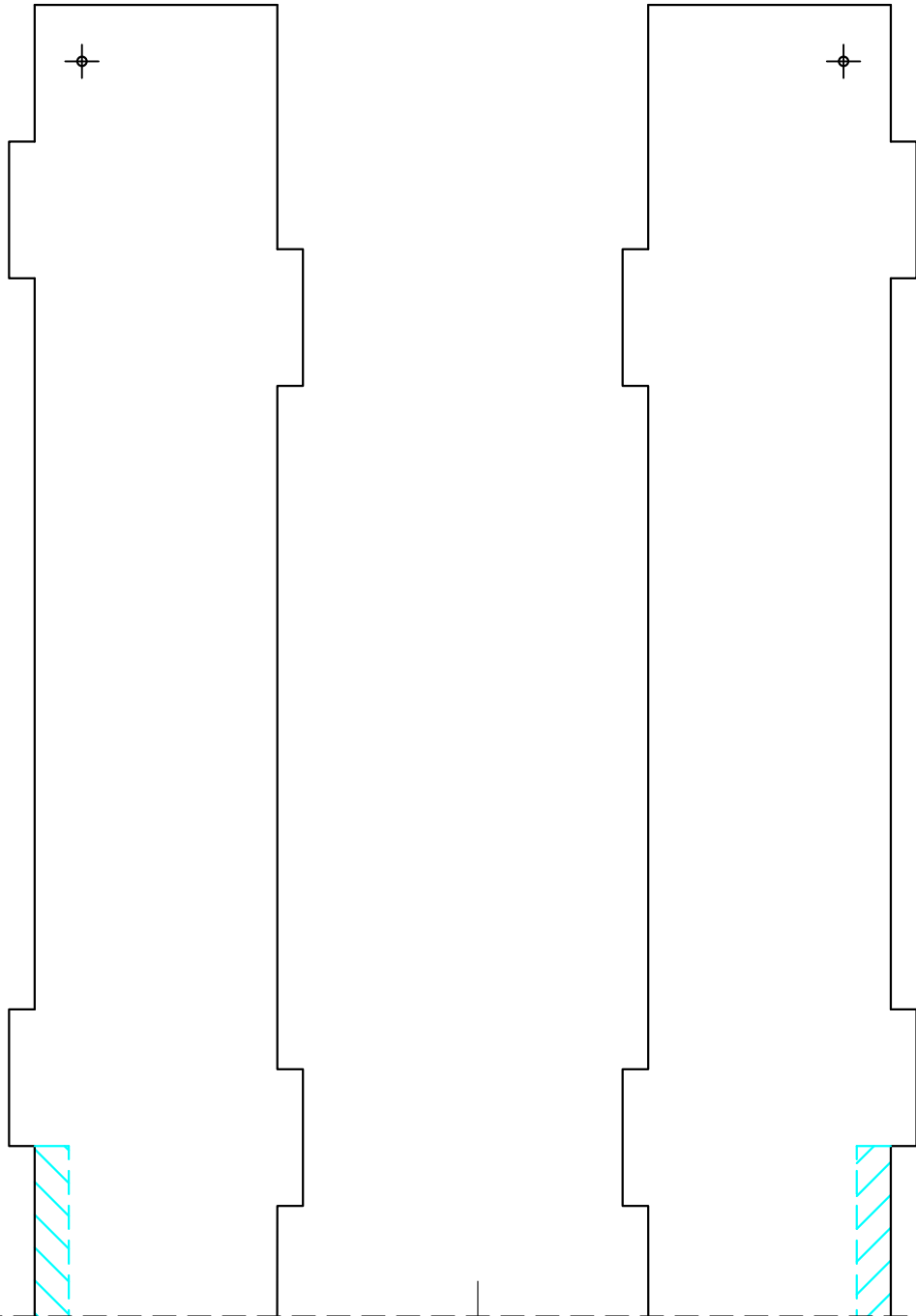

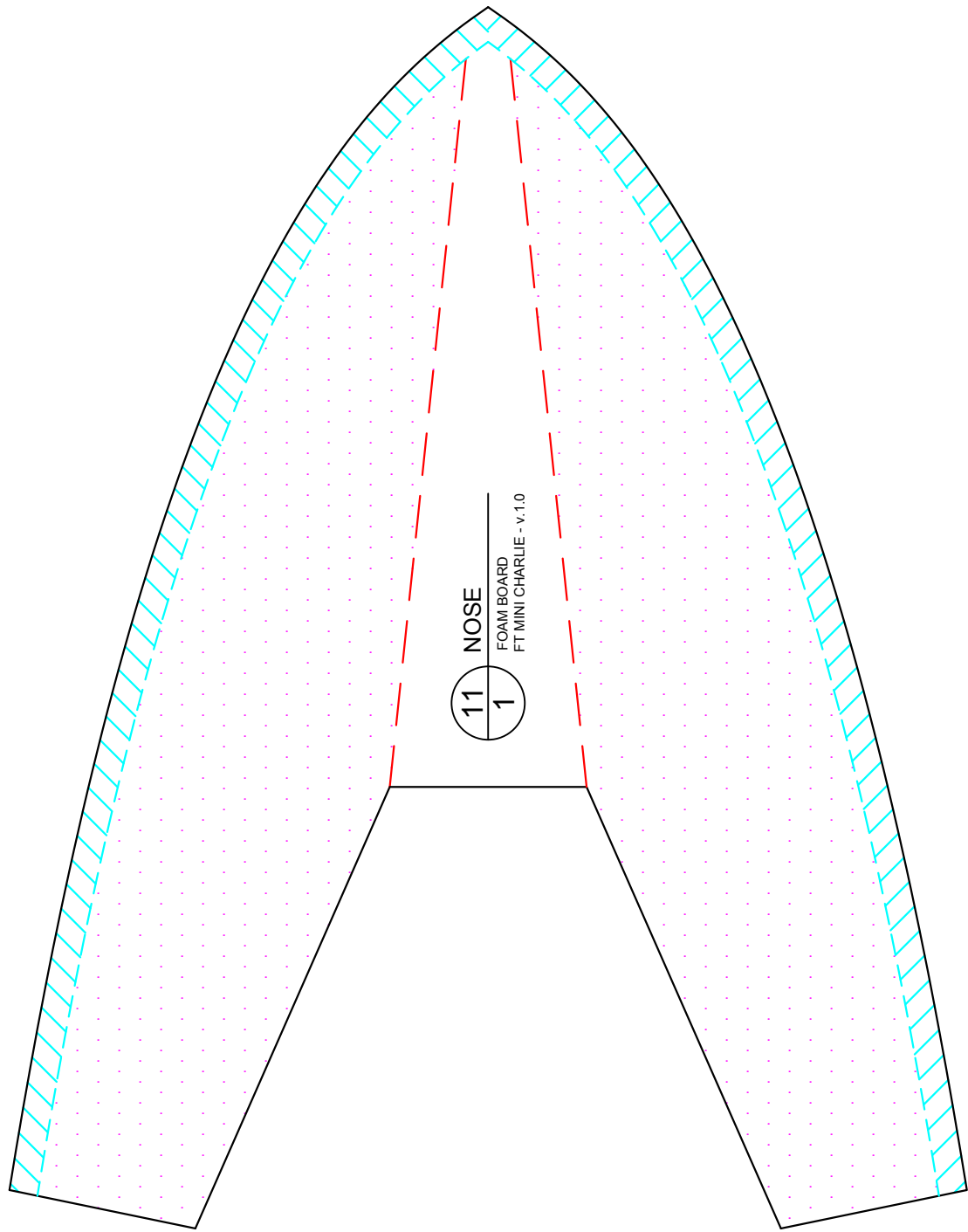
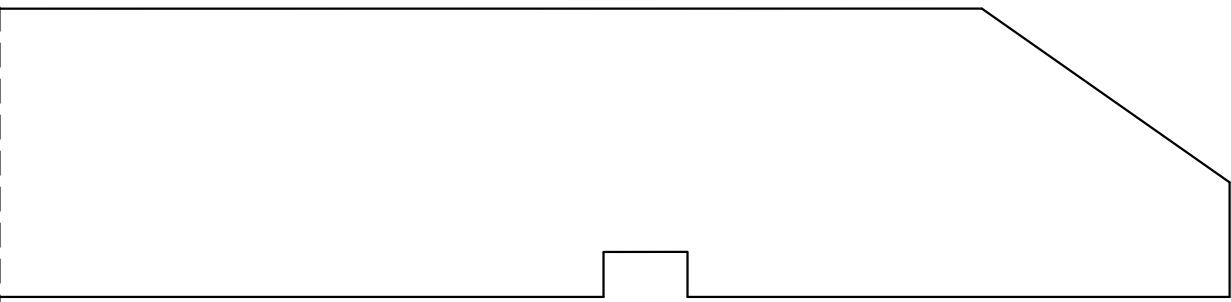

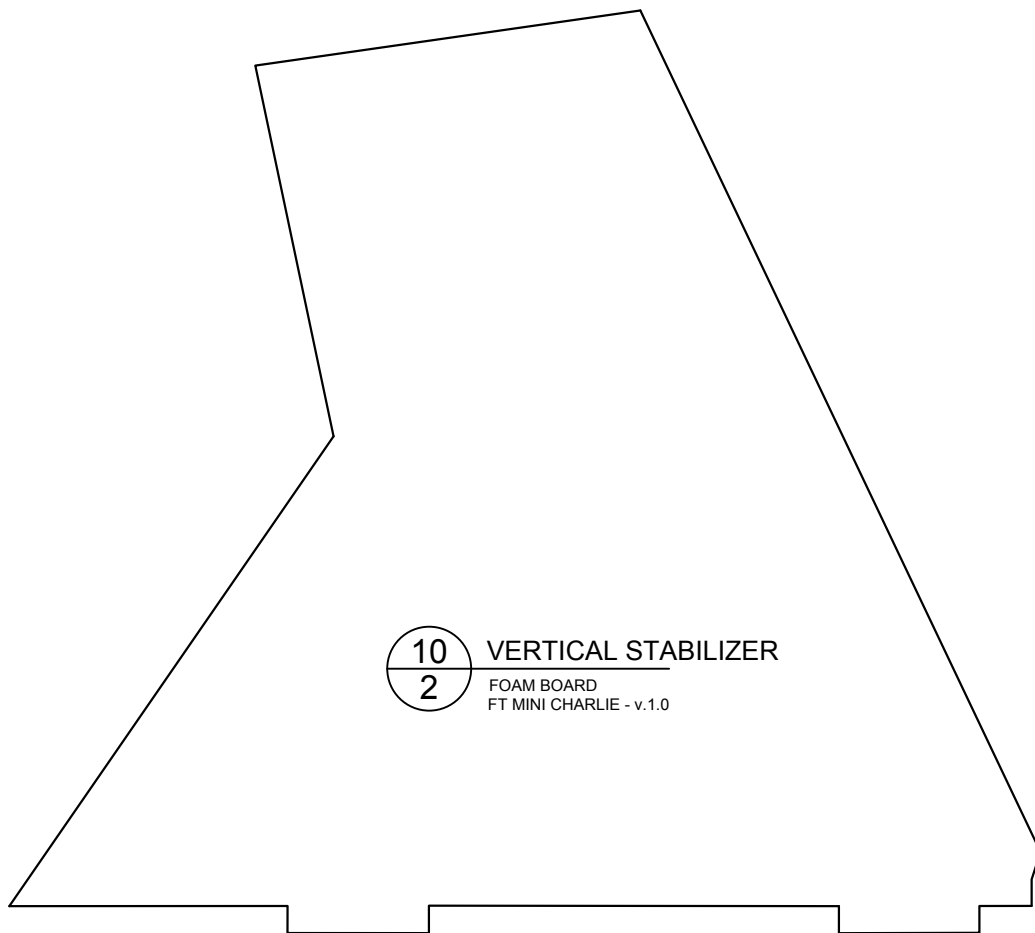

10  
2

**VERTICAL STABILIZER**

FOAM BOARD  
FT MINI CHARLIE - v.1.0

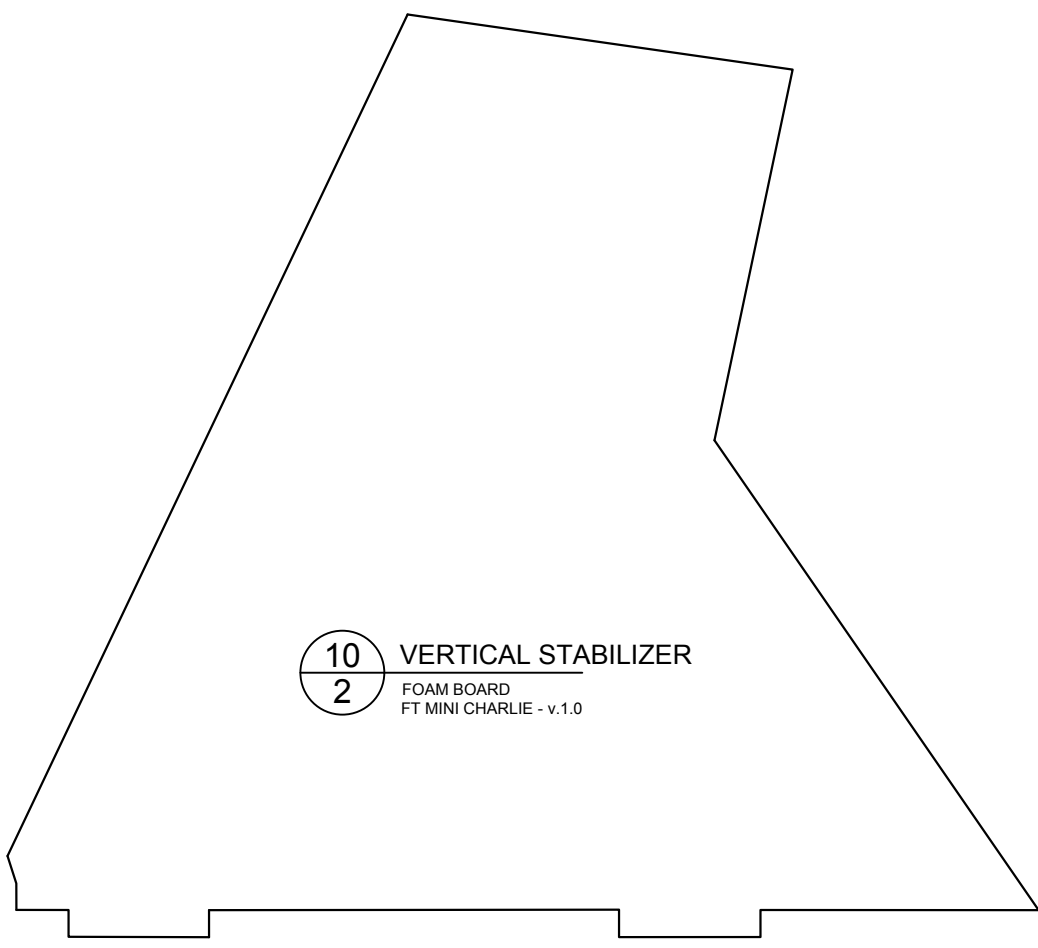

10  
2

**VERTICAL STABILIZER**

FOAM BOARD  
FT MINI CHARLIE - v.1.0

04 LOWER FUSELAGE  
FOAM BOARD  
FT MINI CHARLIE - v.1.0

