



www.flitetest.com

# FT Mini Charlie

Designed By: Kenny Le  
 Drawing By: Dan Sponholz



## SPECIFICATIONS

DESCRIPTION		IMPERIAL	METRIC
LENGTH		27.8 in	705 mm
CENTER OF GRAVITY (FROM NOSE)	CG	14 in	355 mm
WING SPAN		28 in	711 mm
WING AREA		156.2 in <sup>2</sup>	10.1 dm <sup>2</sup>
DRY WEIGHT		8.1 oz	230 g
ALL UP WEIGHT	AUW	10.4 oz	295 g
WING LOADING	WL	9.6 oz/ft <sup>2</sup>	29.2 g/dm <sup>2</sup>
WING CUBIC LOADING	WCL	9.2	

## RECOMMENDED SETTINGS

	THROW	EXPO
ELEVONS	16°	30%

Build Skill Level :



Pilot Skill Level :



## SHEET & TILE KEY



1	2	3	4
5	6	7	8

9	10	11	12
13	14	15	16

17	18	19	20
21	<del>22</del>	<del>23</del>	<del>24</del>

# DRAWING KEY

## FOLD TYPES

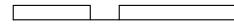
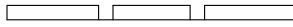
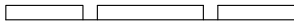
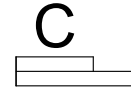
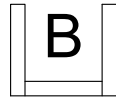
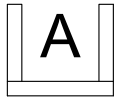

A - FOLD (ABOVE)

B - FOLD (BESIDE)

C - FOLD (COVER)

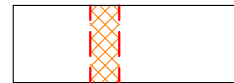
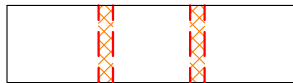
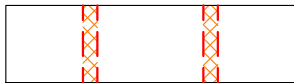

## LINE TYPE/COLOR

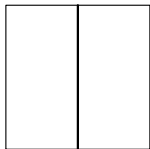

CUT

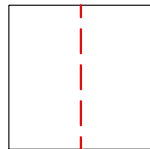

50% SCORE

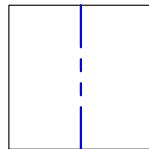
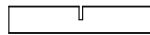

CREASE

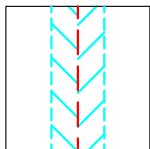
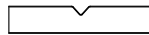

45° DOUBLE BEVEL

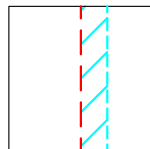

45° SINGLE BEVEL

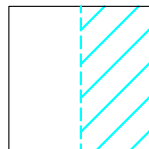

EDGE BEVEL

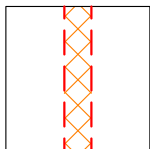

CAVITY

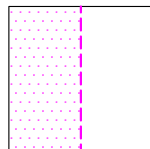

REMOVE PAPER

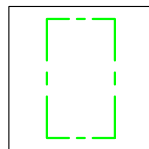
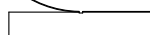

REFERENCE/  
OPTIONAL

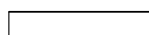

## SYMBOLS

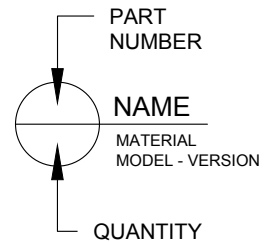

DOWEL HOLE



CENTER OF GRAVITY (CG)

# FT Mini Charlie

Designed By: Kenny Le  
Drawing By: Dan Sponholz



IN   
CM

SHEET 1 OF 3

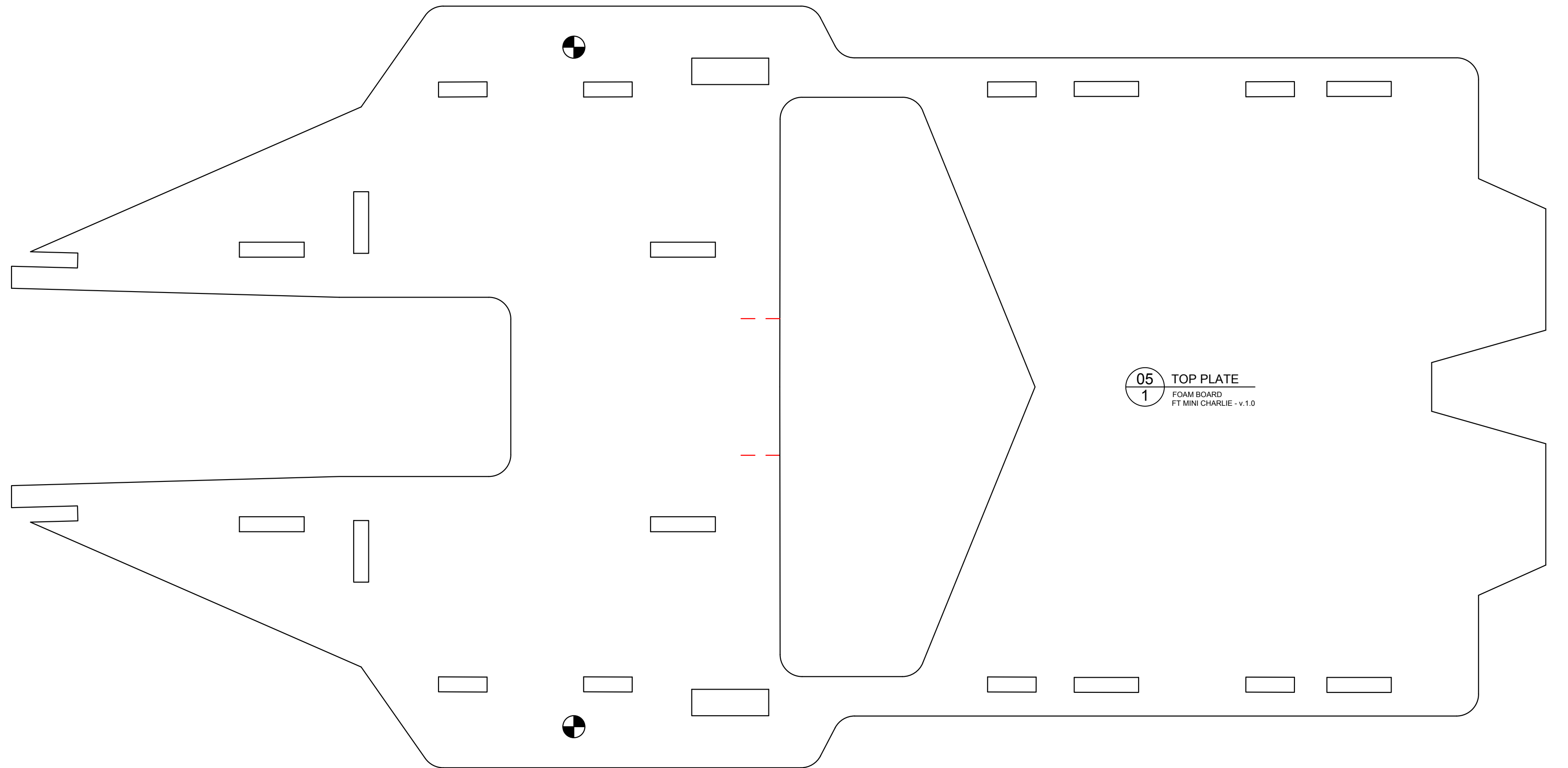
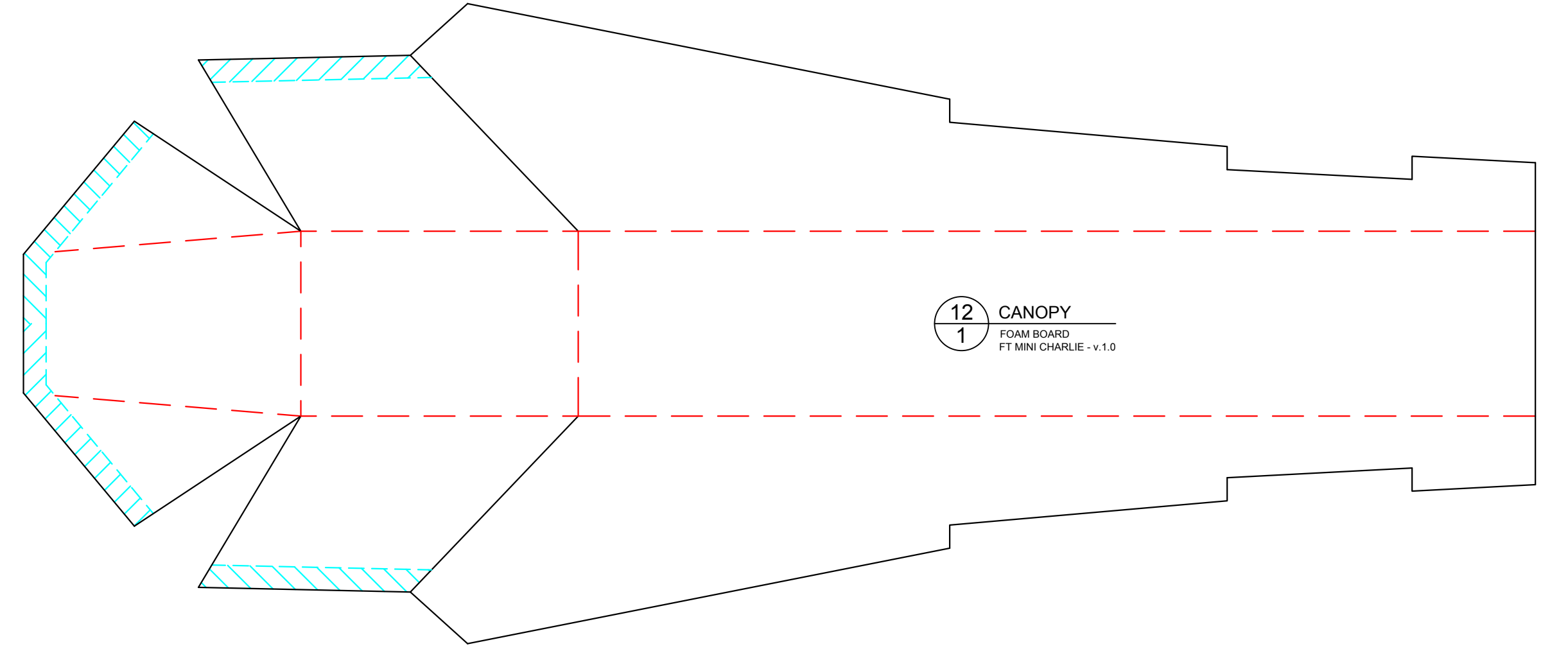
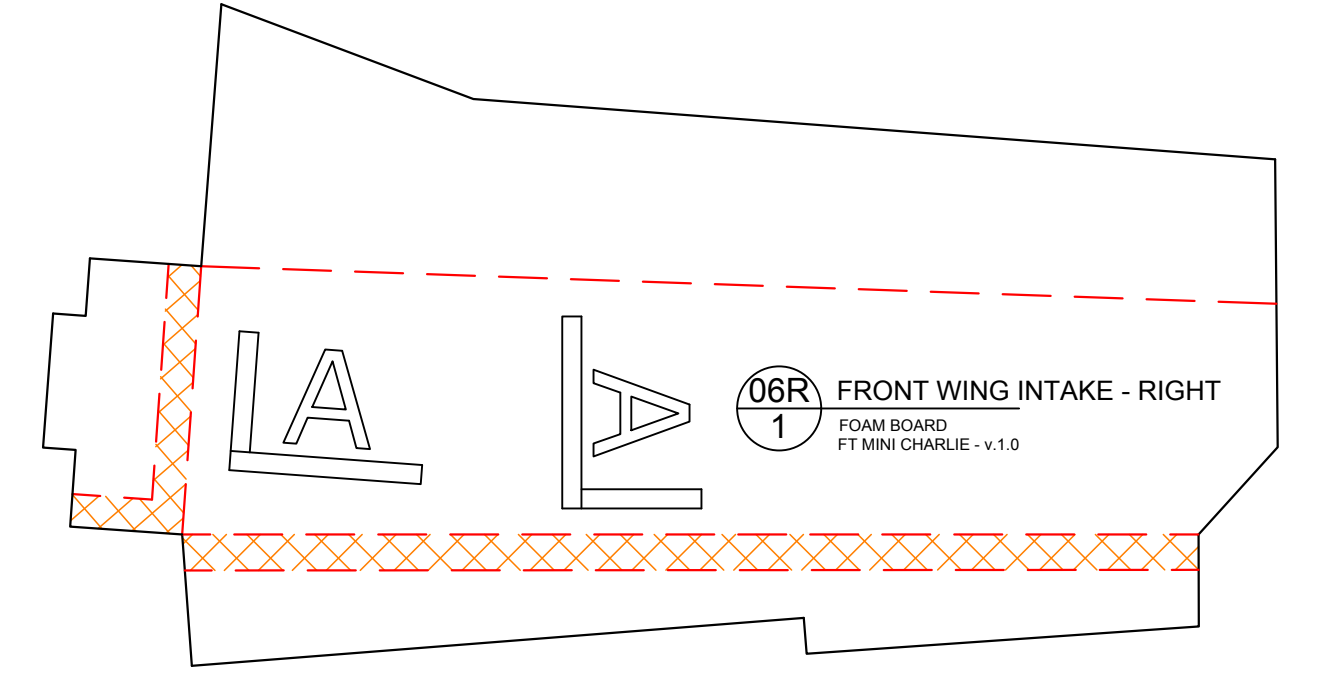
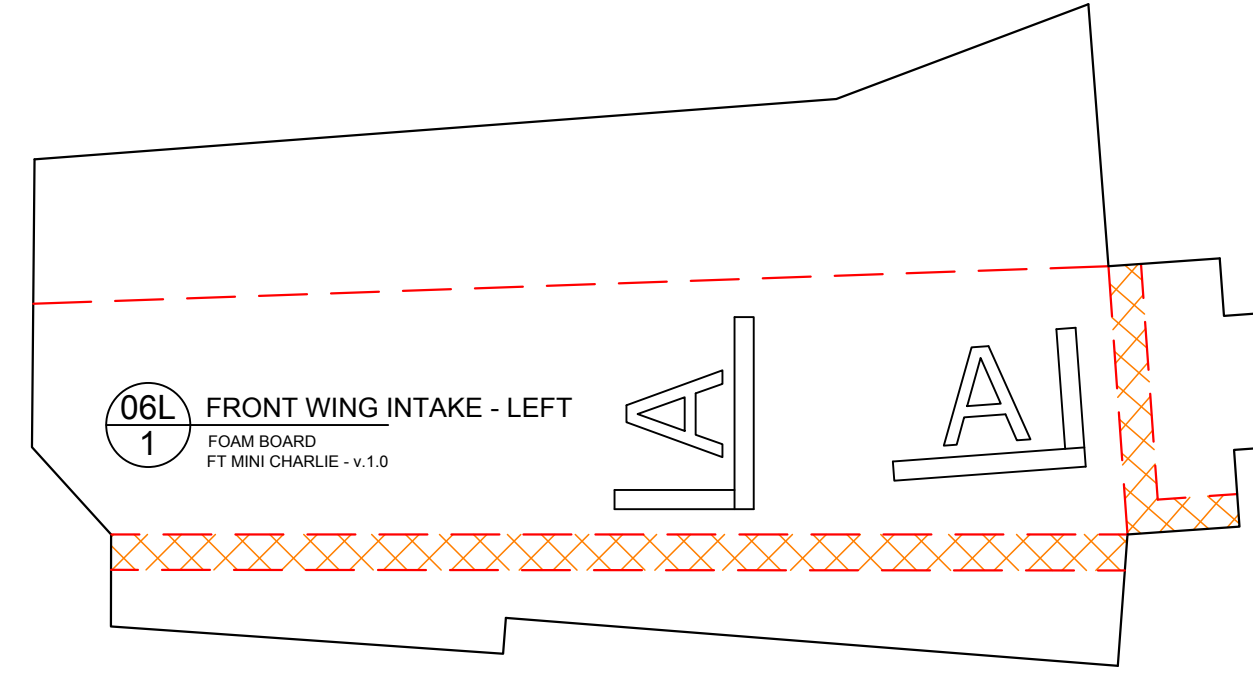
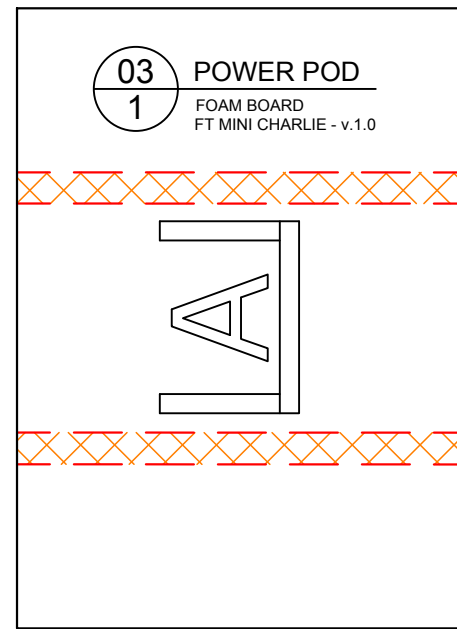
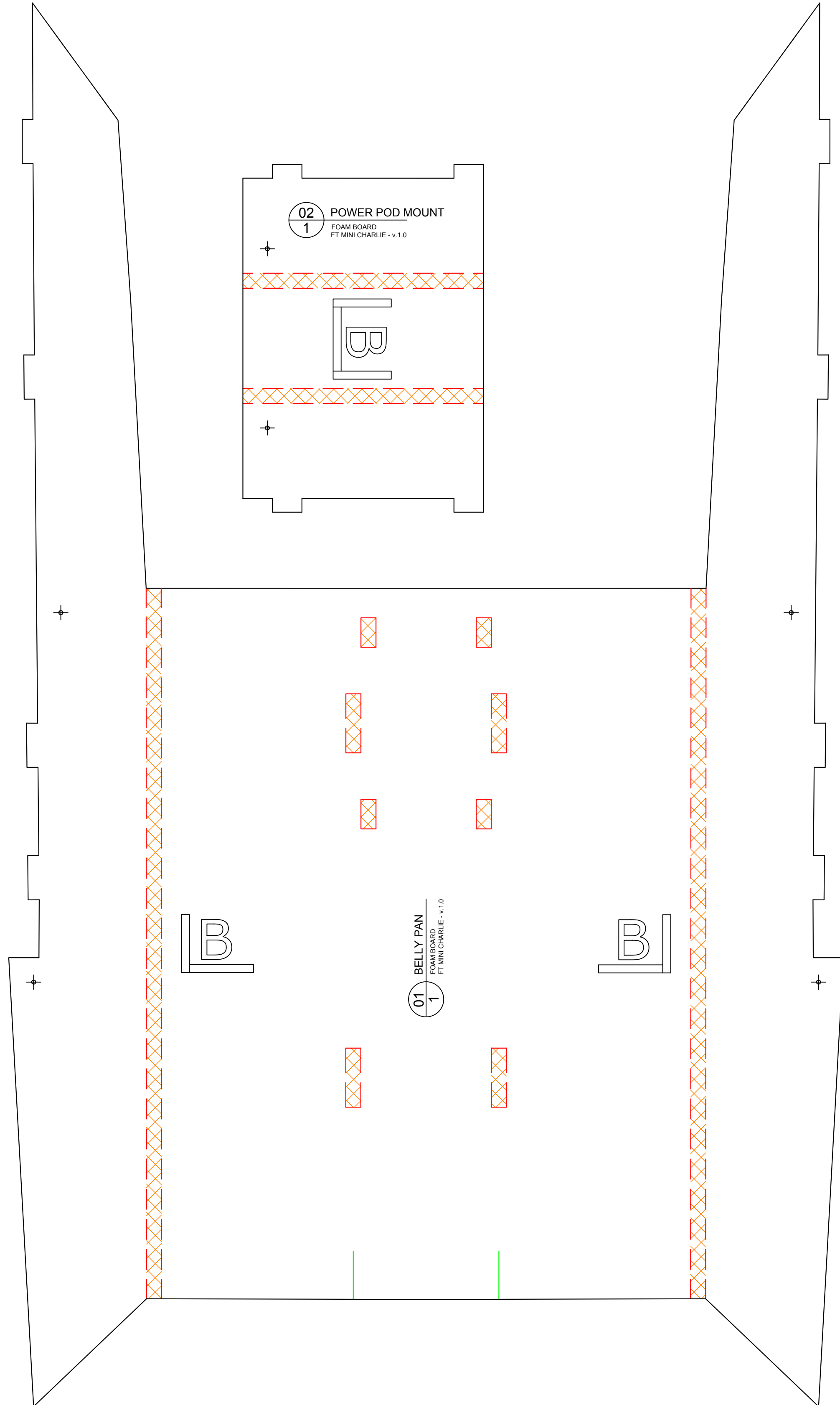
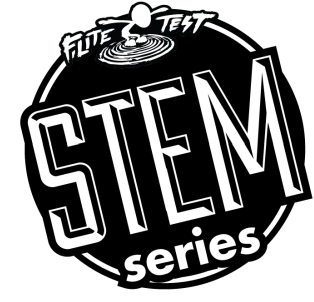

www.flitetest.com

# FT Mini Charlie

Designed By: Kenny Le  
Drawing By: Dan Sponholz

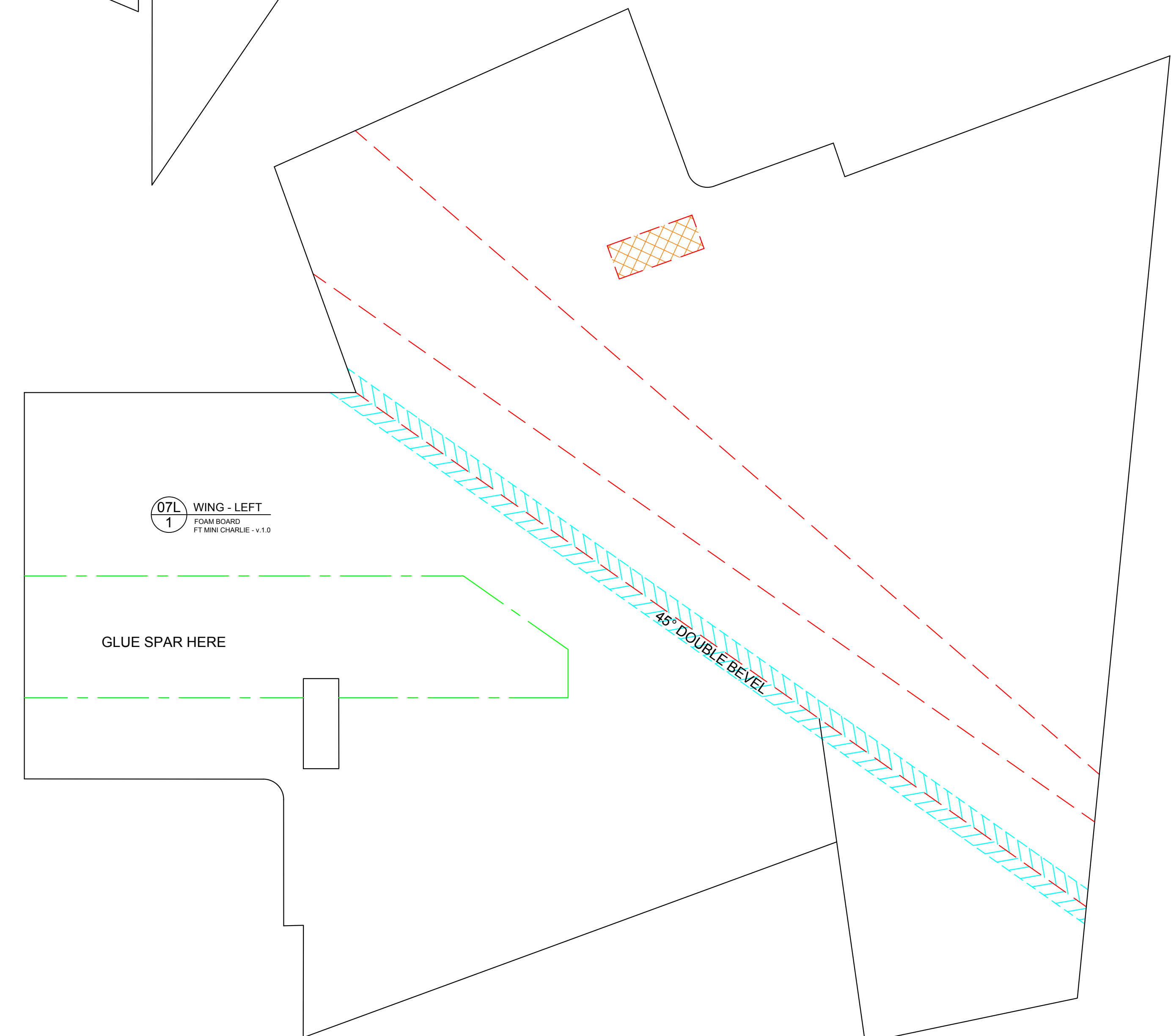
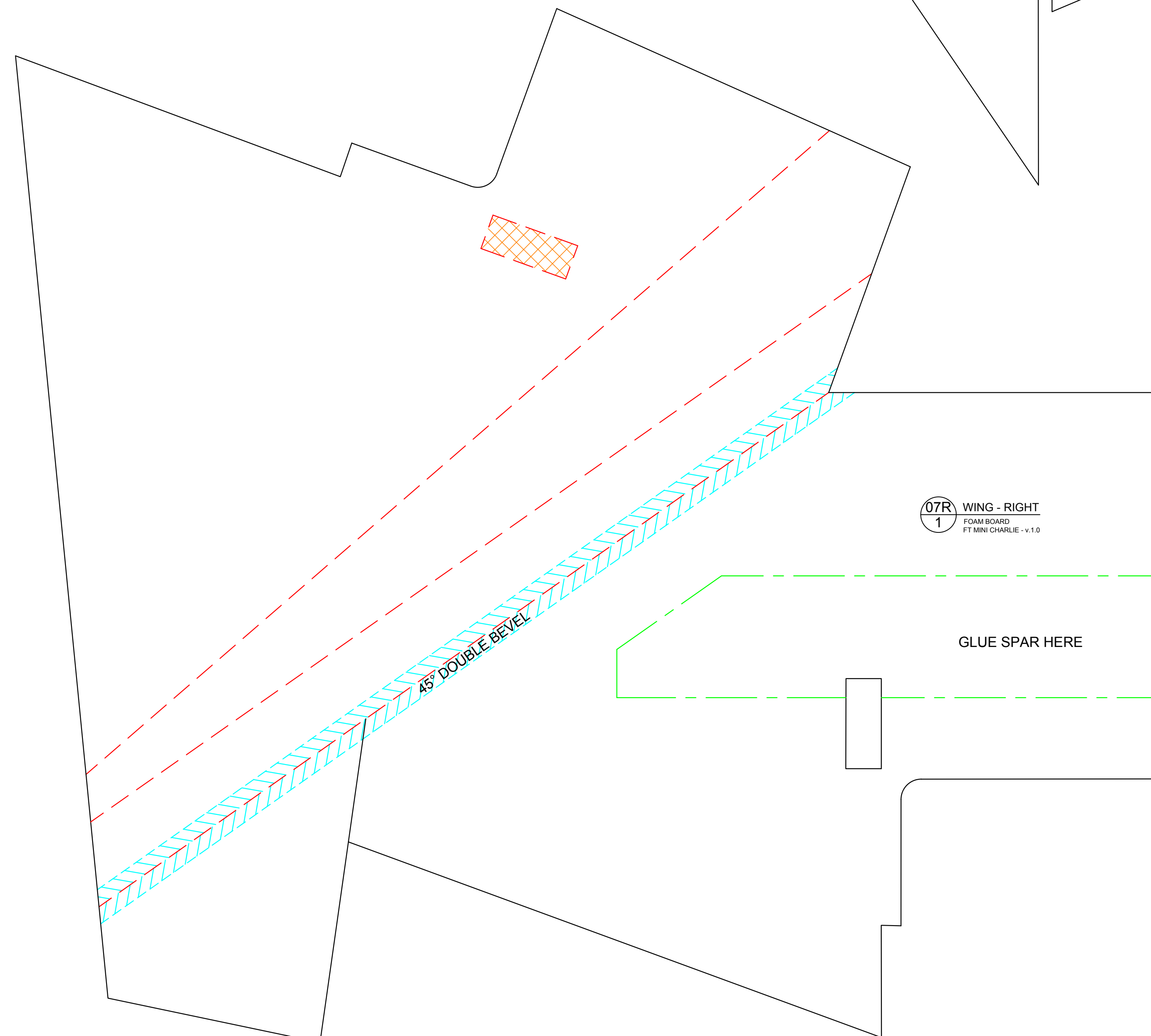
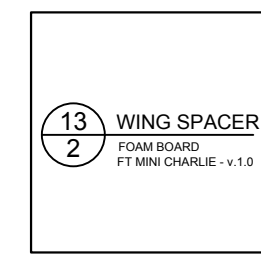
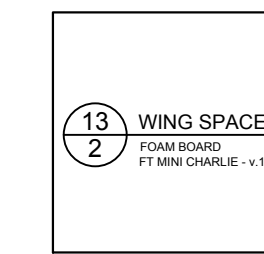
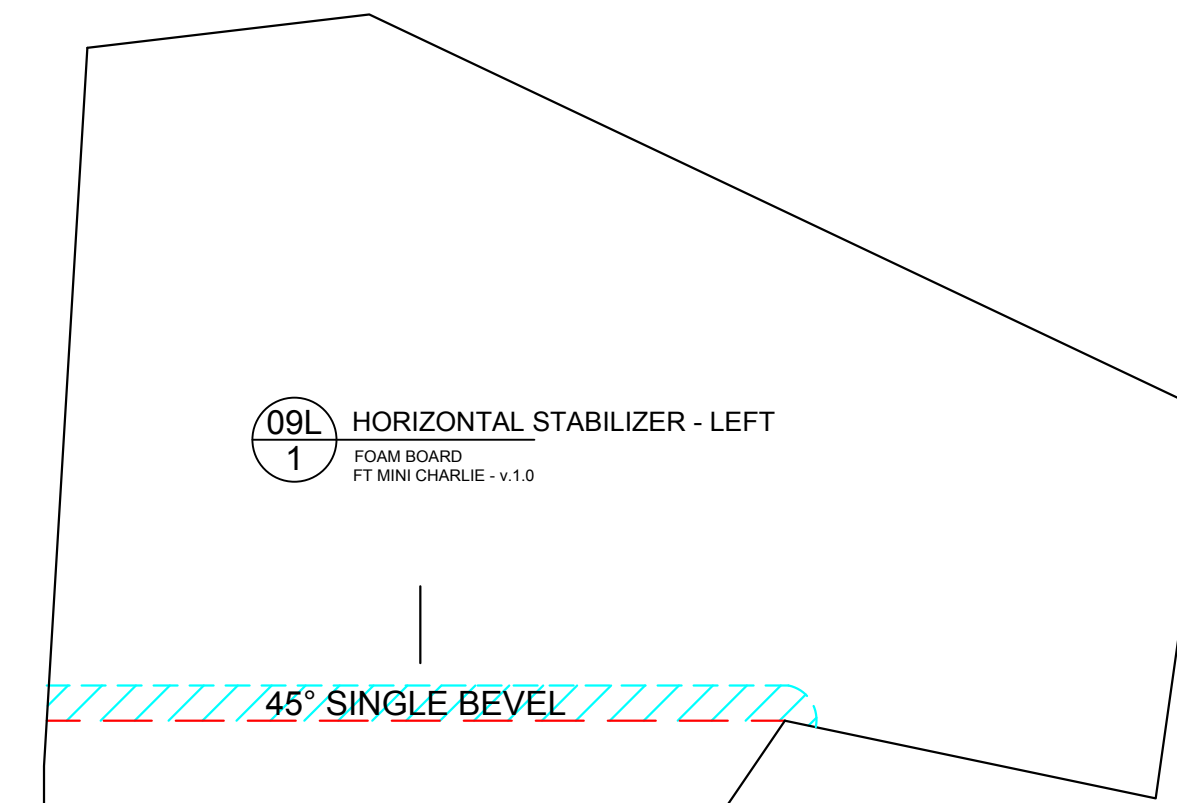
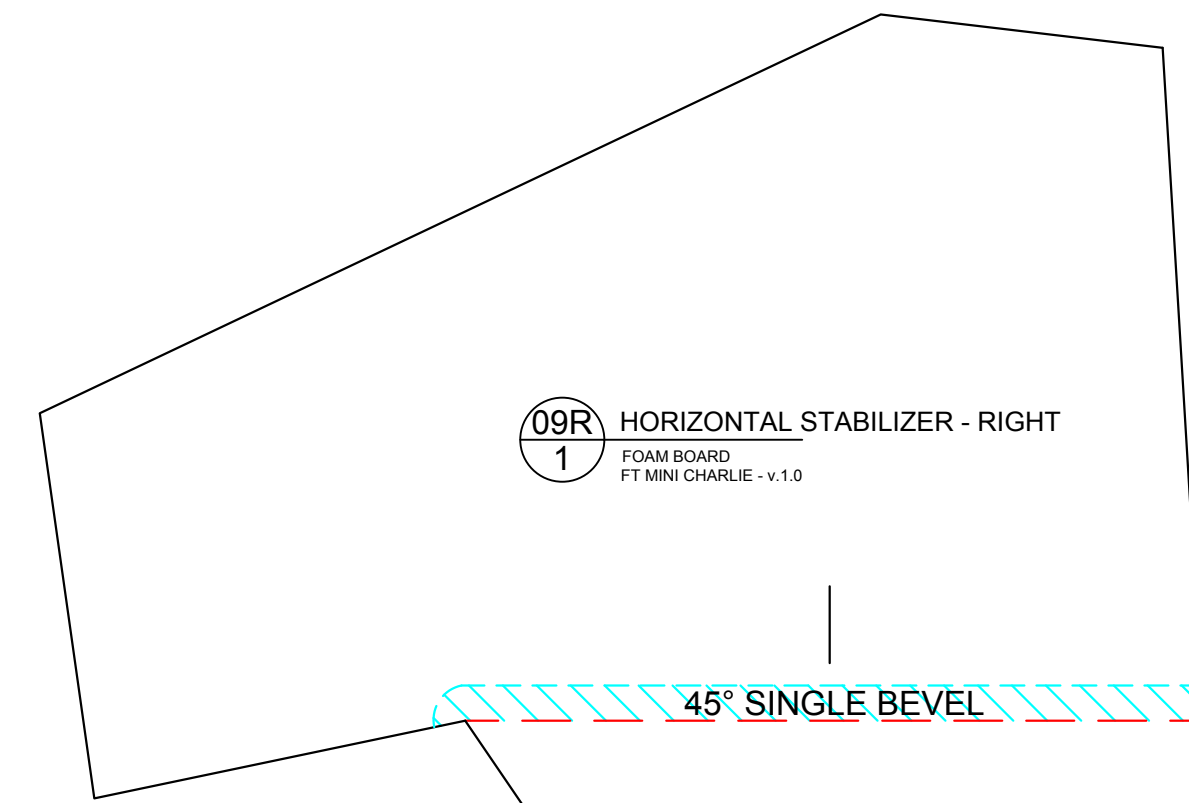
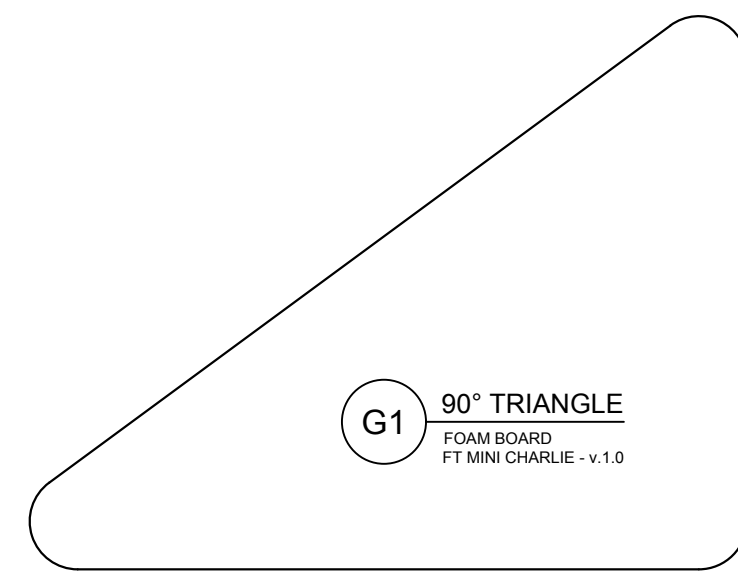

# FT Mini Charlie

Designed By: Kenny Le  
Drawing By: Dan Sponholz

