



www.flitetest.com

FT Mini Charlie

Designed By: Kenny Le
 Drawing By: Dan Sponholz



SPECIFICATIONS

DESCRIPTION		IMPERIAL	METRIC
LENGTH		27.8 in	705 mm
CENTER OF GRAVITY (FROM NOSE)	CG	14 in	355 mm
WING SPAN		28 in	711 mm
WING AREA		156.2 in ²	10.1 dm ²
DRY WEIGHT		8.1 oz	230 g
ALL UP WEIGHT	AUW	10.4 oz	295 g
WING LOADING	WL	9.6 oz/ft ²	29.2 g/dm ²
WING CUBIC LOADING	WCL	9.2	

RECOMMENDED SETTINGS

	THROW	EXPO
ELEVONS	16°	30%

Build Skill Level :



Pilot Skill Level :



SHEET & TILE KEY



1	2	3	4
5	6	7	8

9	10	11	12
13	14	15	16

17	18	19	20
21	22	23	24

DRAWING KEY

FOLD TYPES

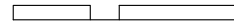
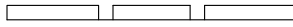
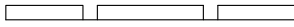
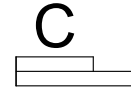
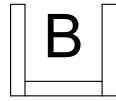
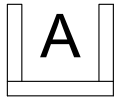

A - FOLD (ABOVE)

B - FOLD (BESIDE)

C - FOLD (COVER)

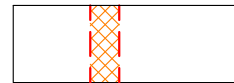
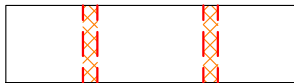

LINE TYPE/COLOR

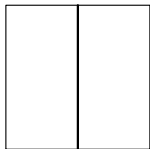

CUT

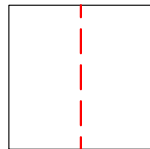

50% SCORE

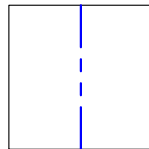
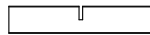

CREASE

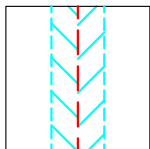
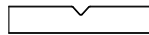

45° DOUBLE BEVEL

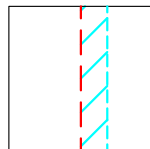

45° SINGLE BEVEL

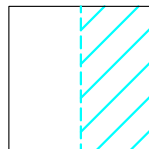

EDGE BEVEL

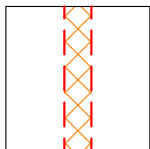

CAVITY

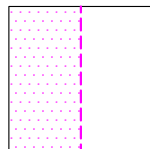

REMOVE PAPER

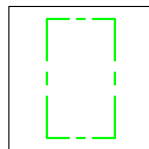

REFERENCE/
OPTIONAL

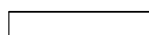

SYMBOLS

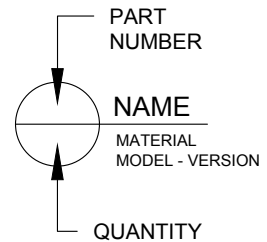

DOWEL HOLE



CENTER OF GRAVITY (CG)

FT Mini Charlie

Designed By: Kenny Le
Drawing By: Dan Sponholz



IN
CM

SHEET 1 OF 3

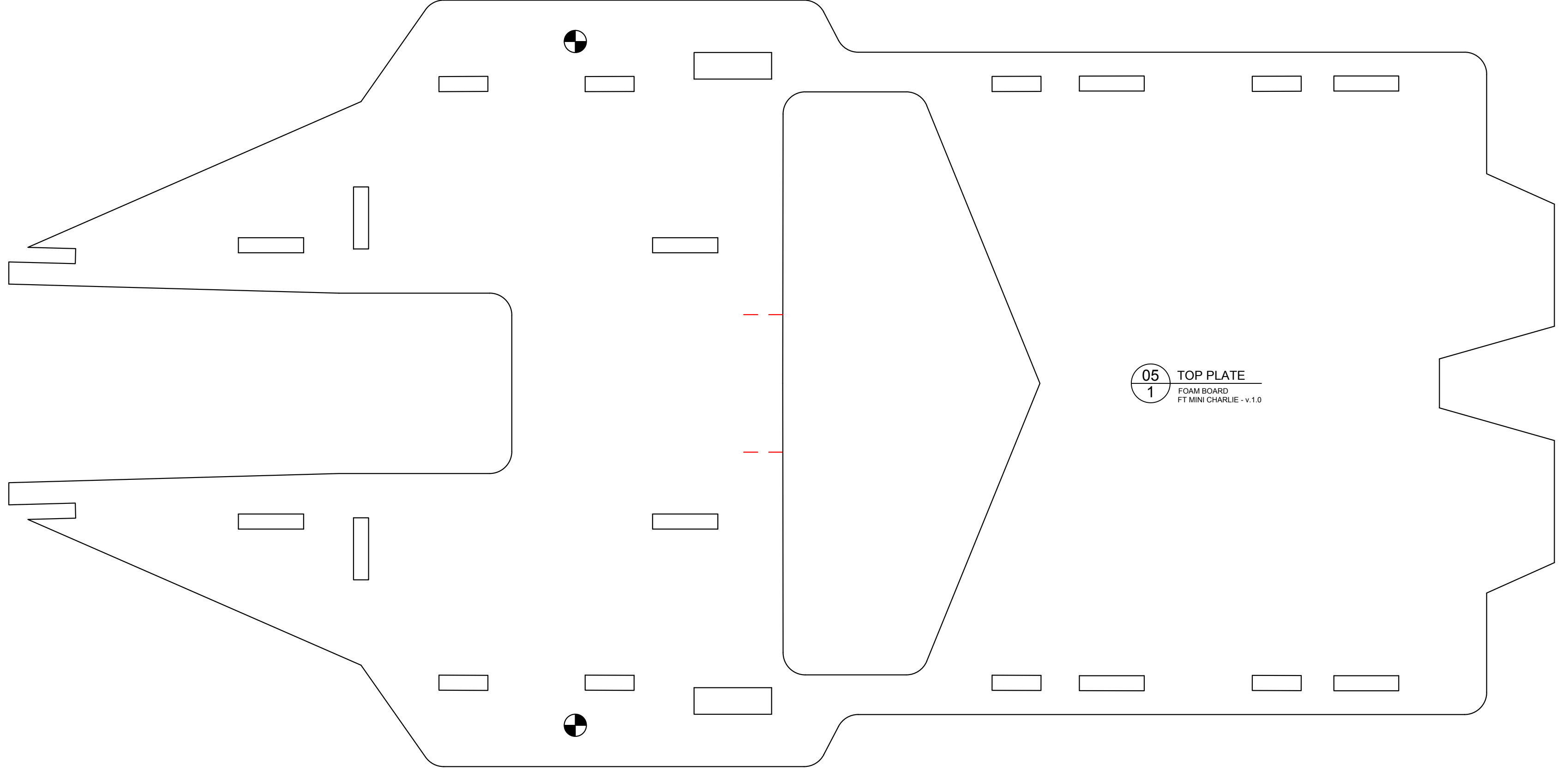
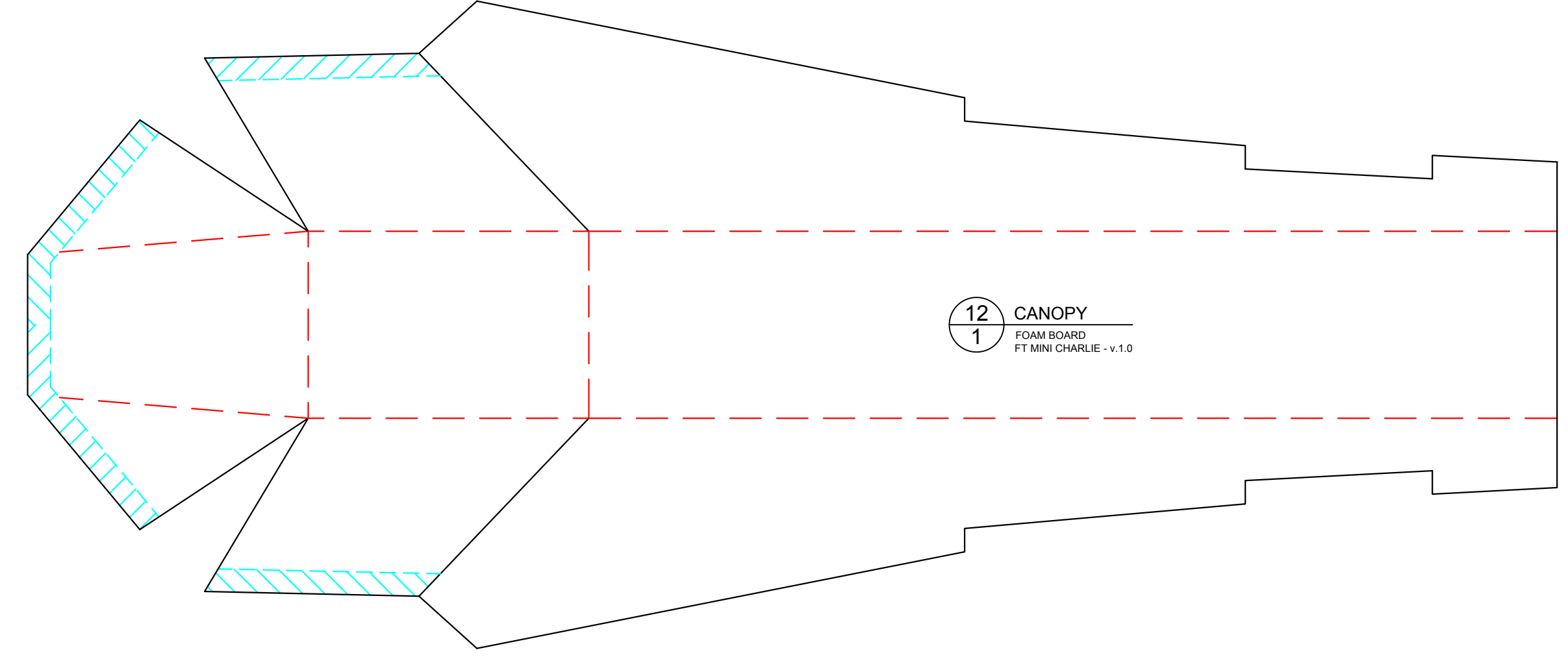
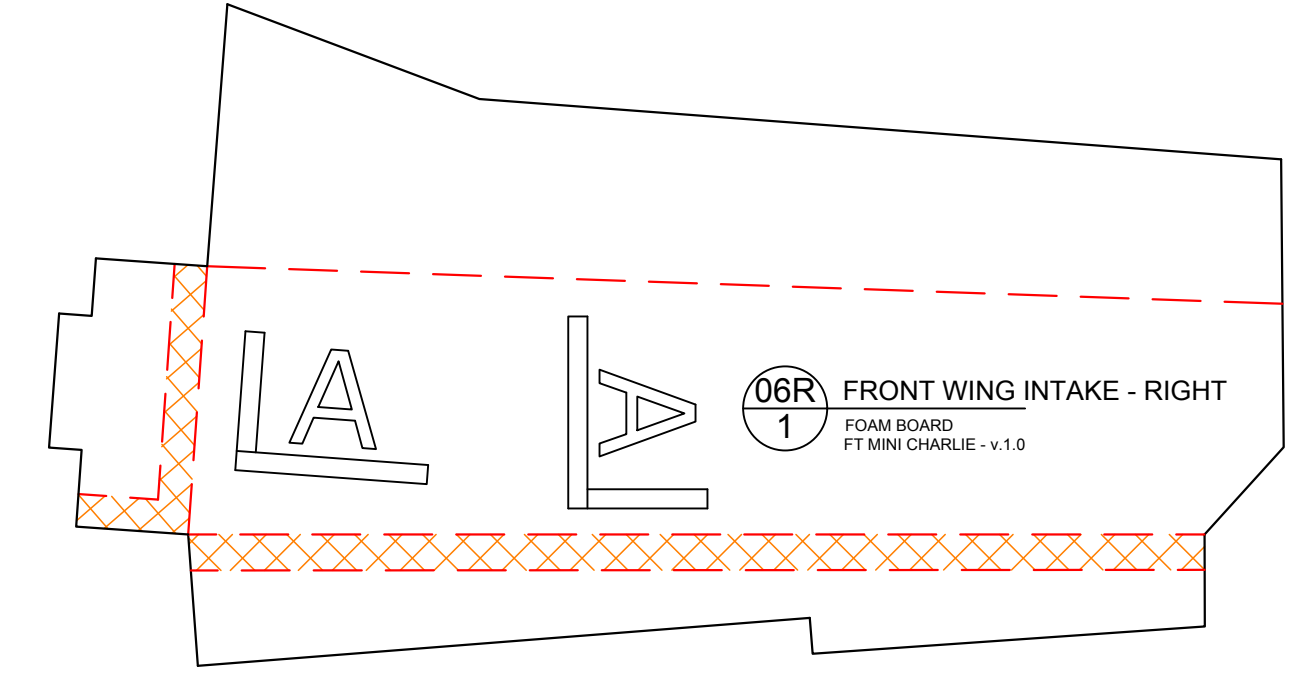
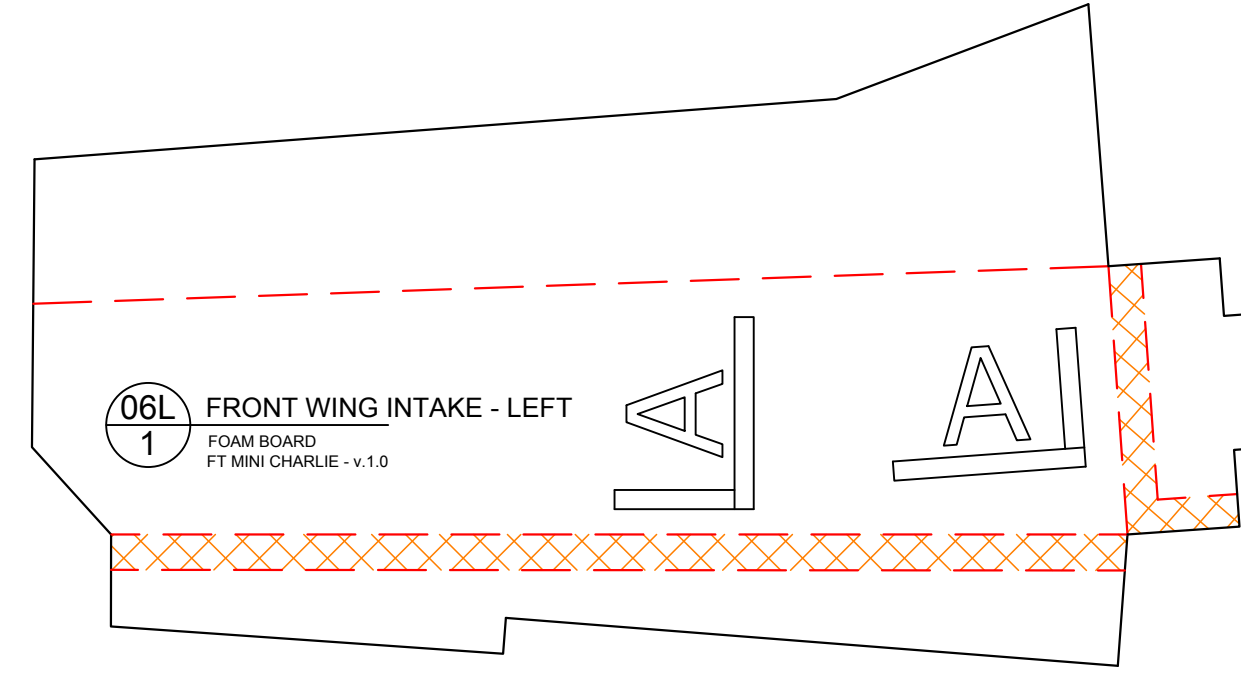
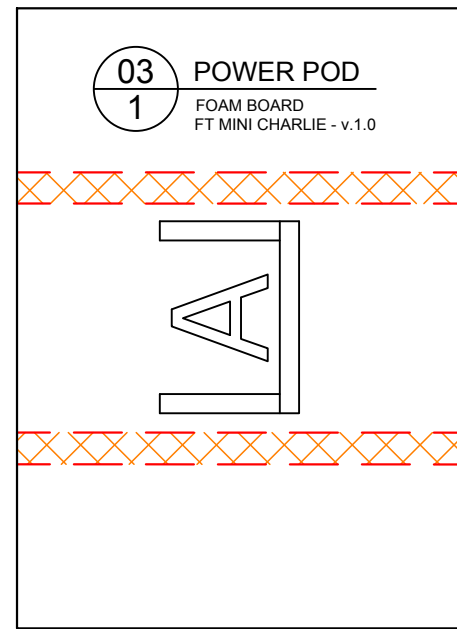
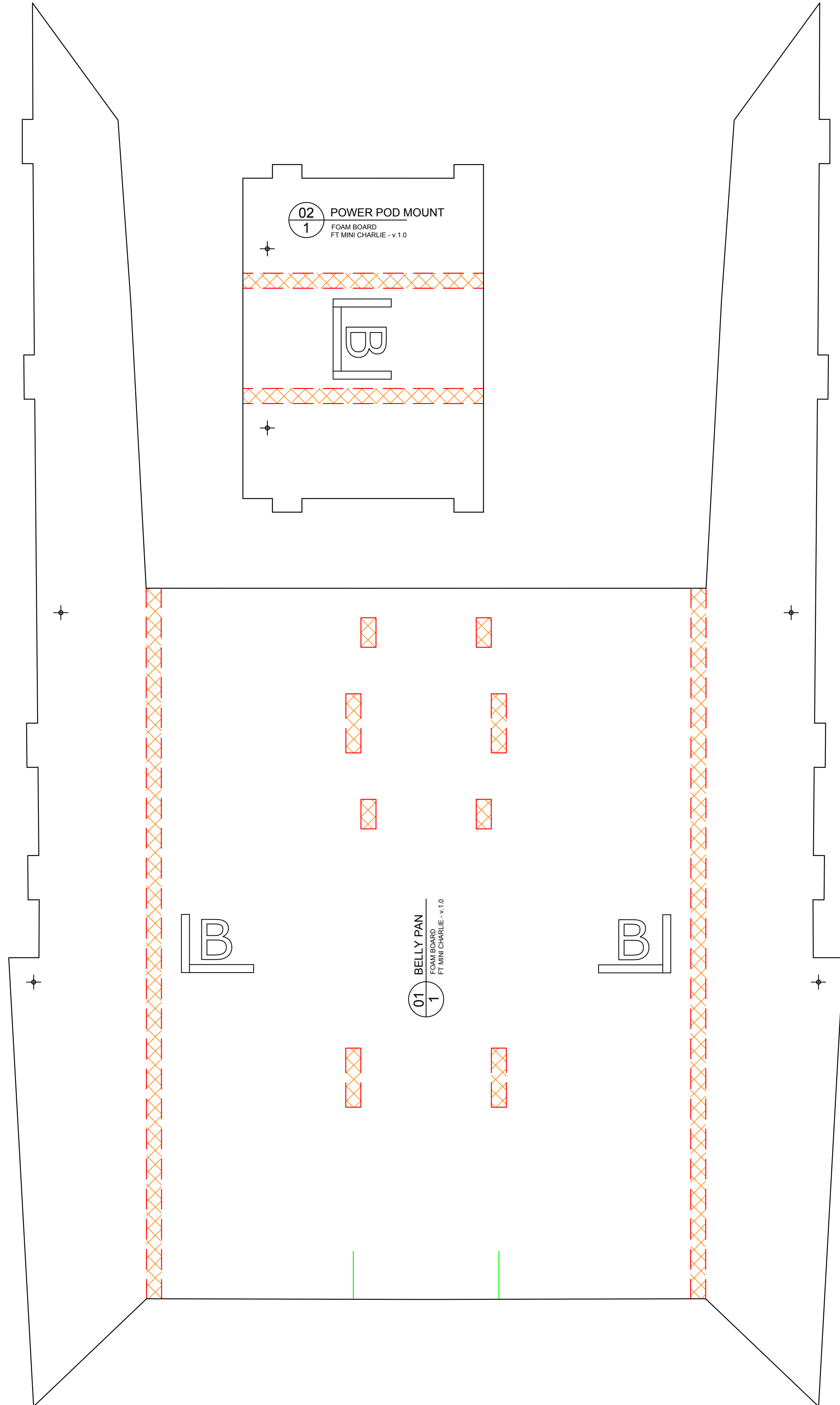
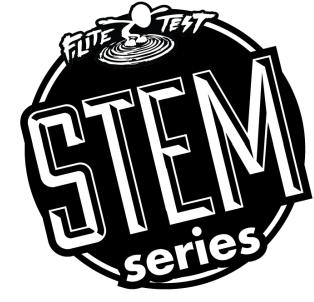

www.flitetest.com

FT Mini Charlie

Designed By: Kenny Le
Drawing By: Dan Sponholz

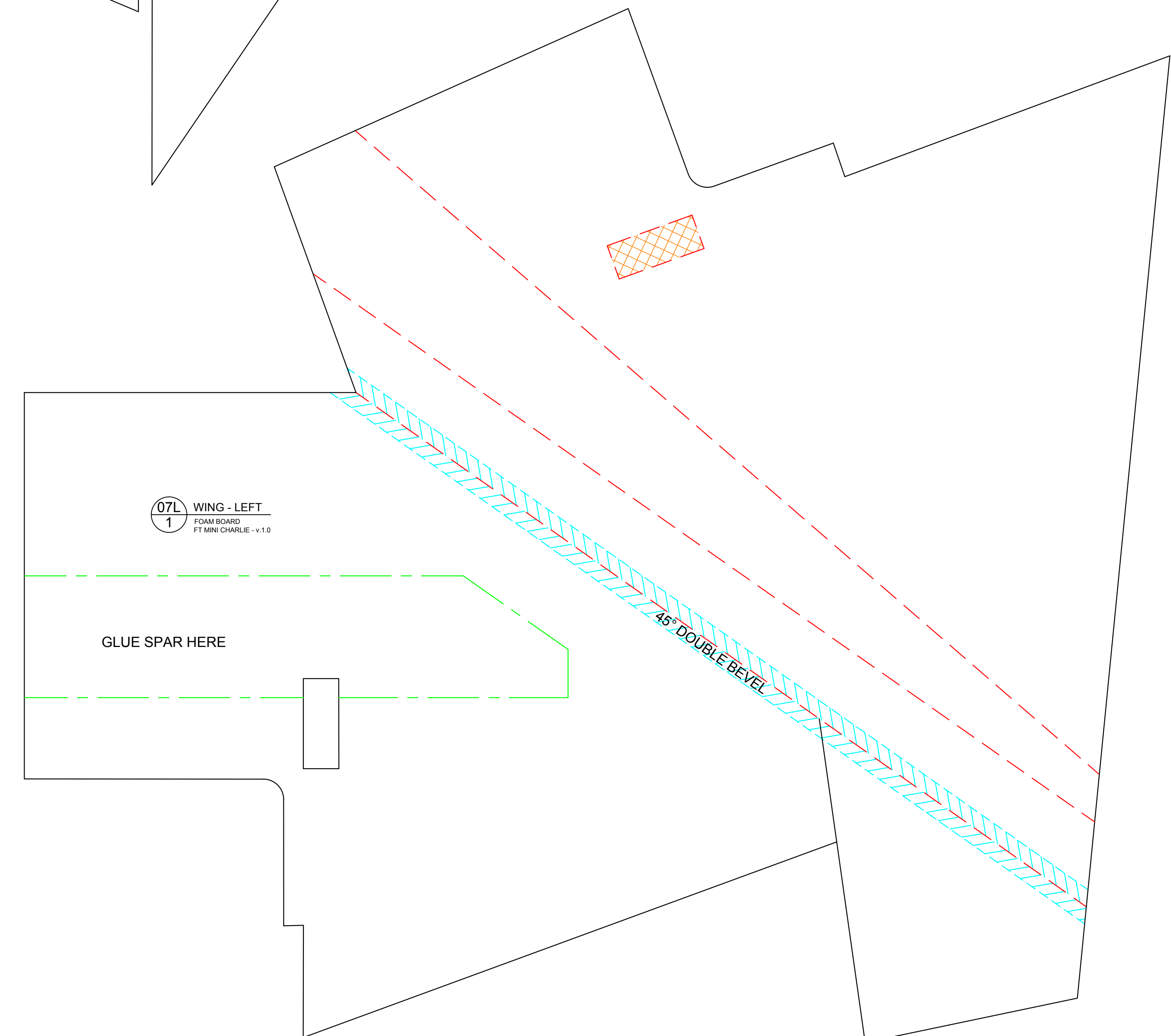
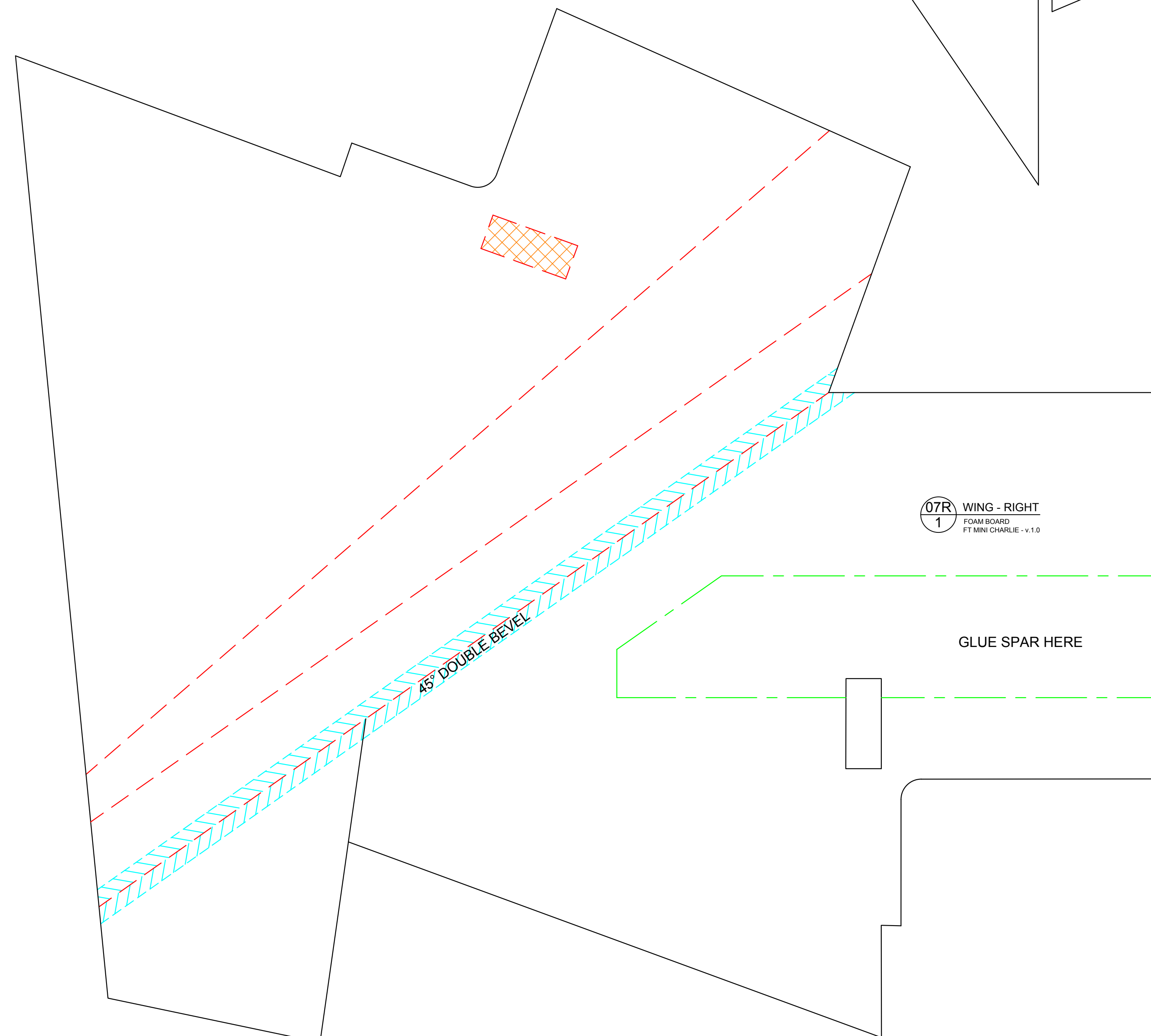
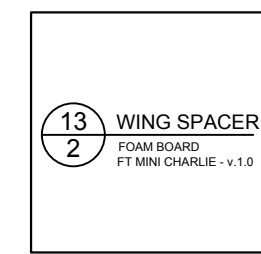
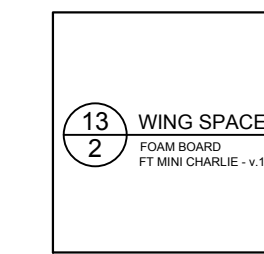
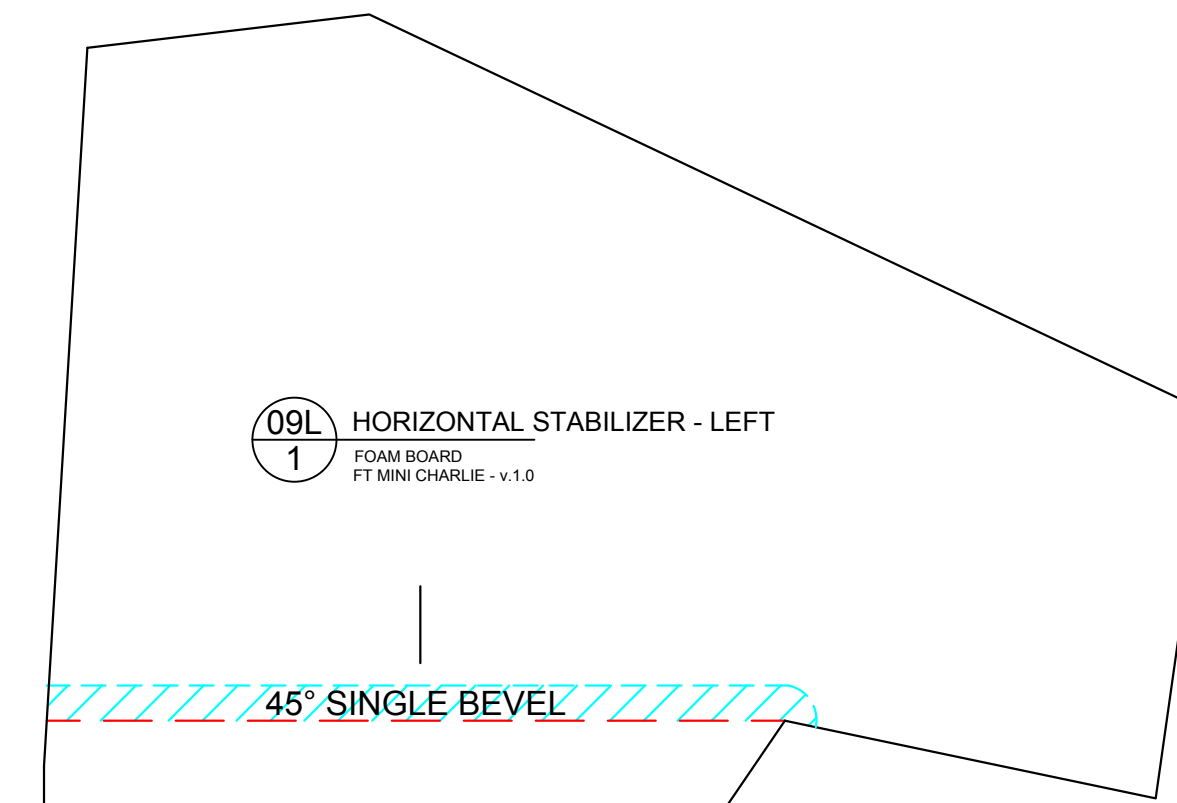
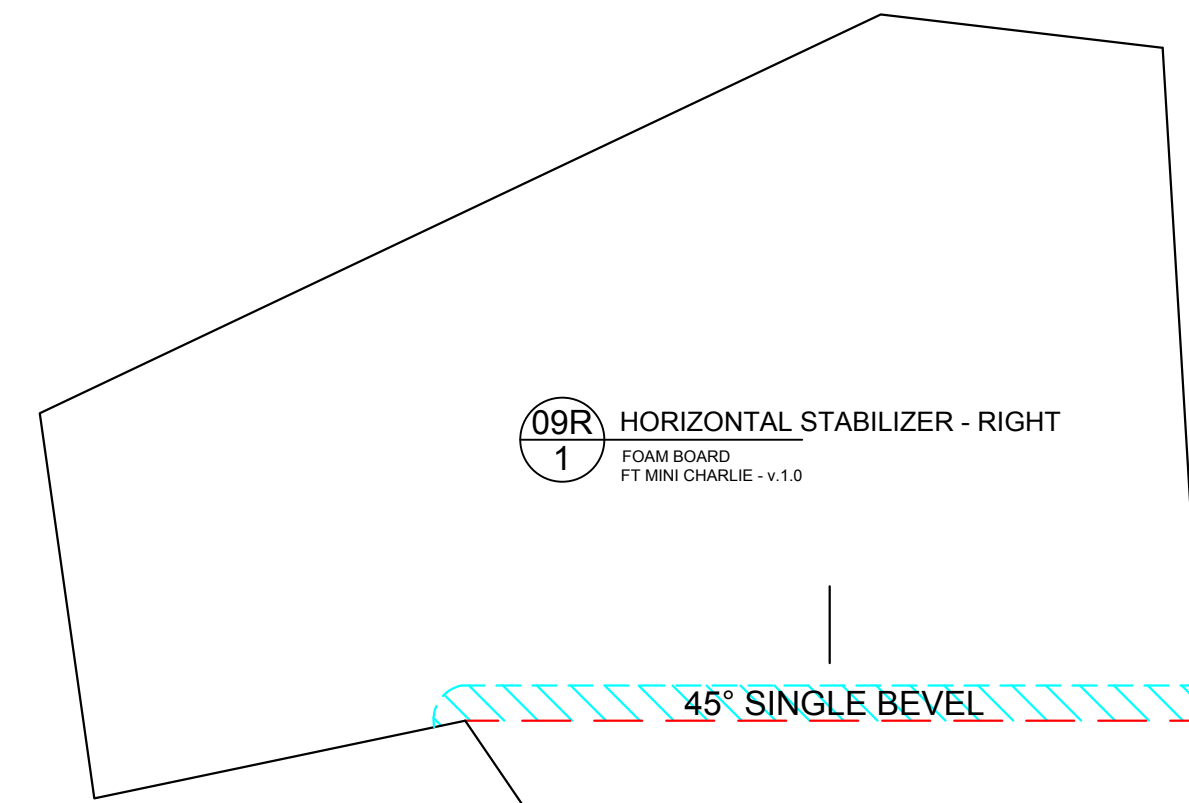
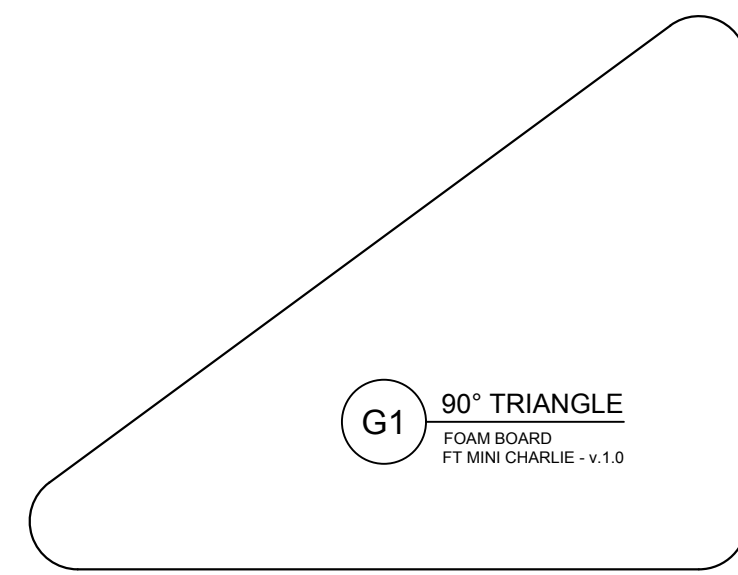

FT Mini Charlie

Designed By: Kenny Le
Drawing By: Dan Sponholz

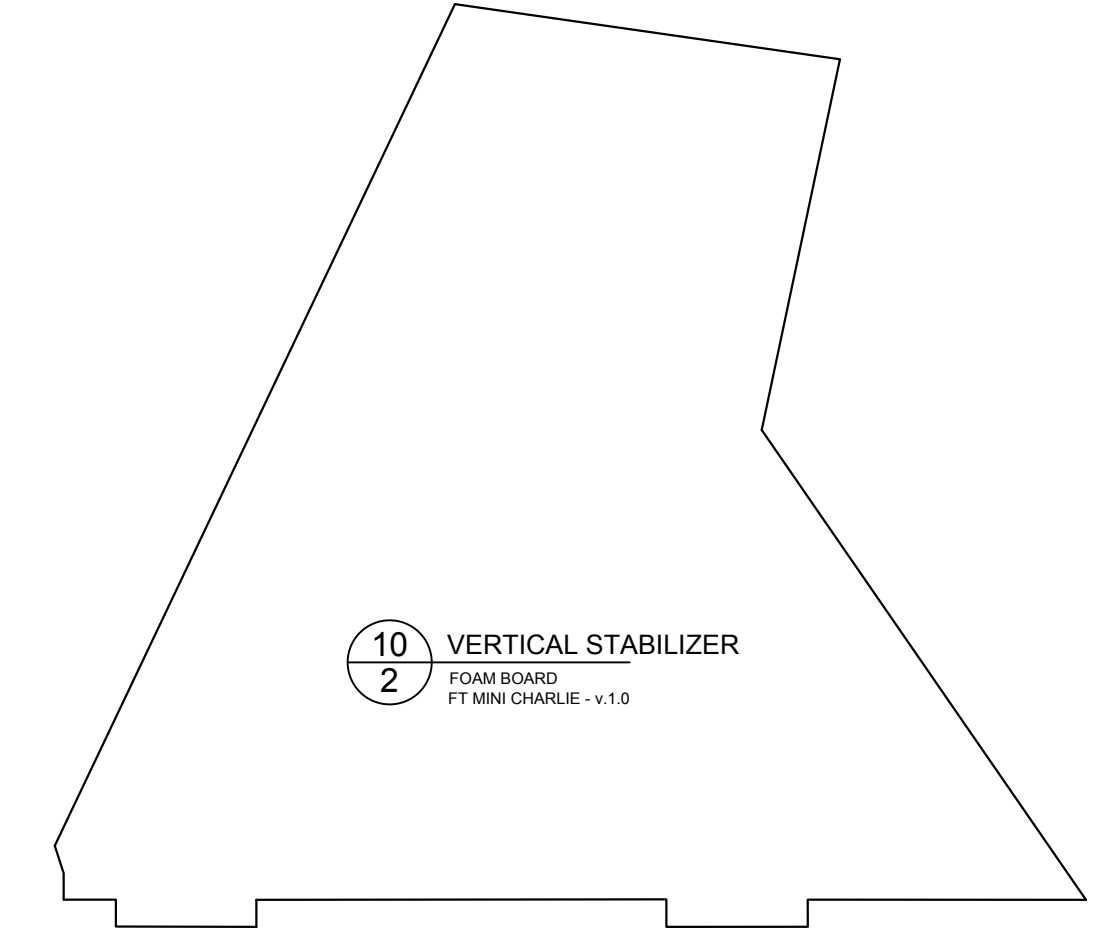
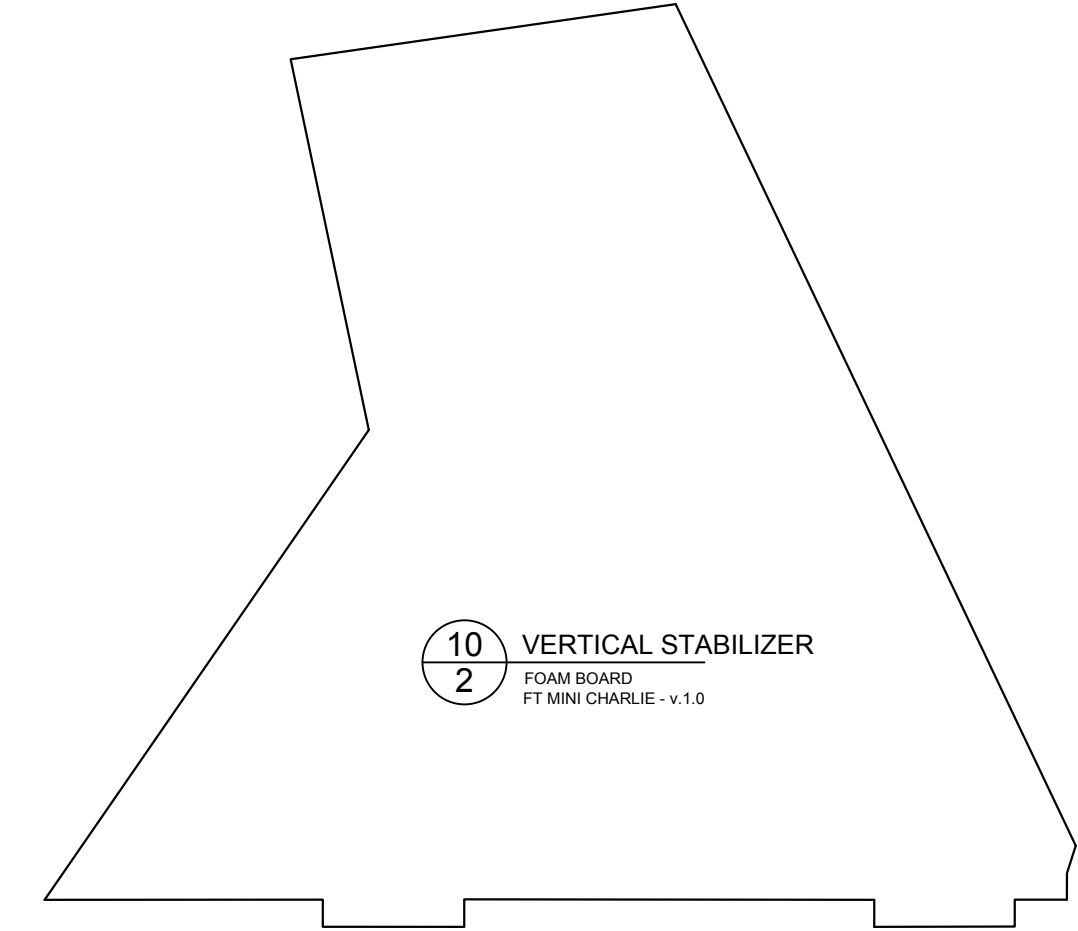
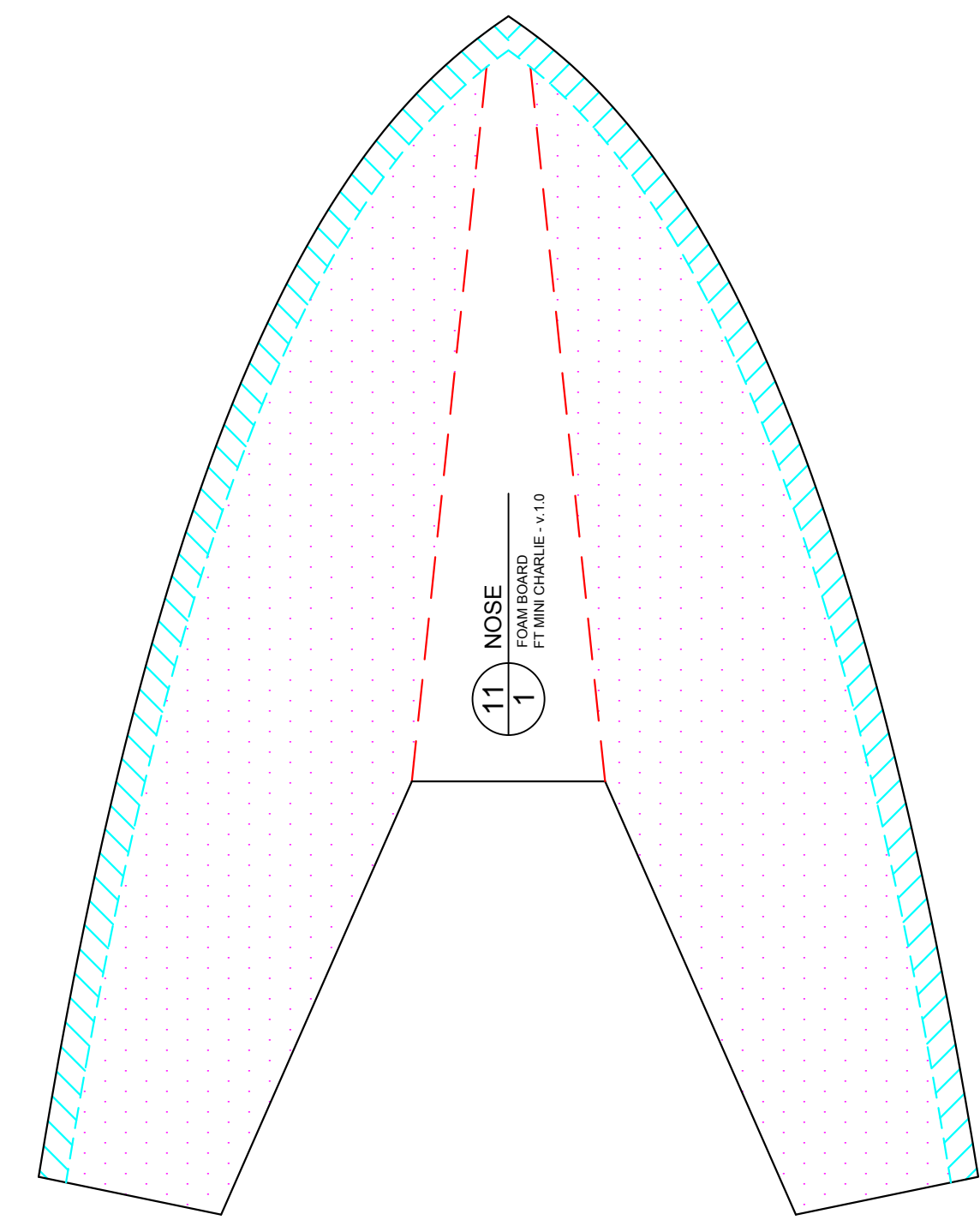
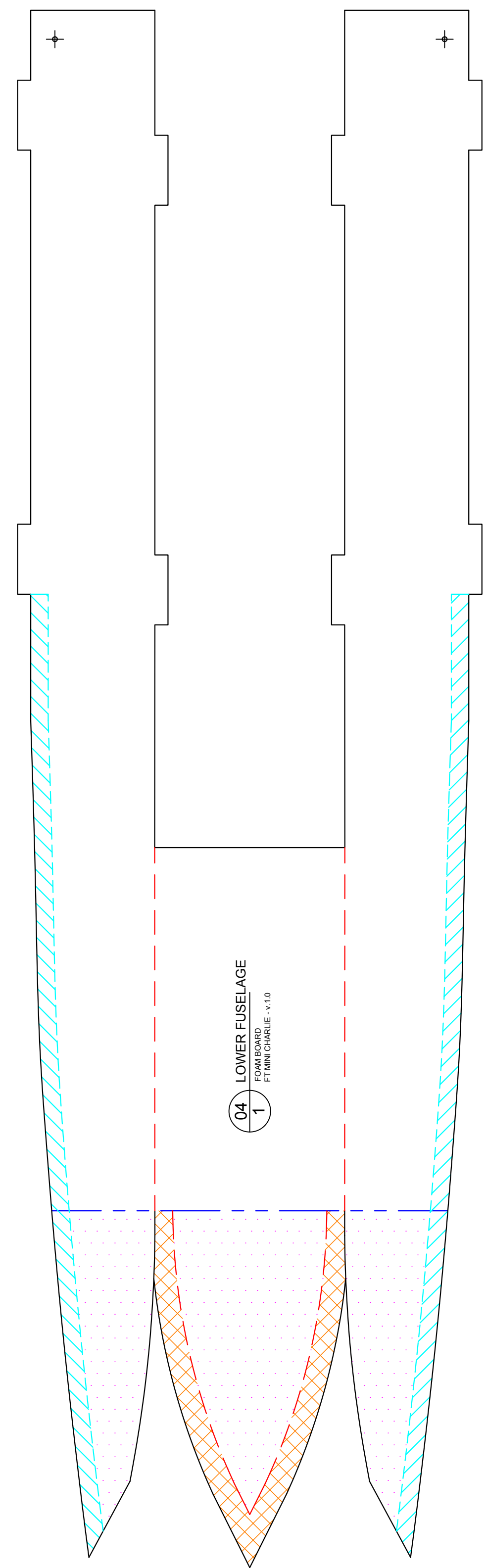
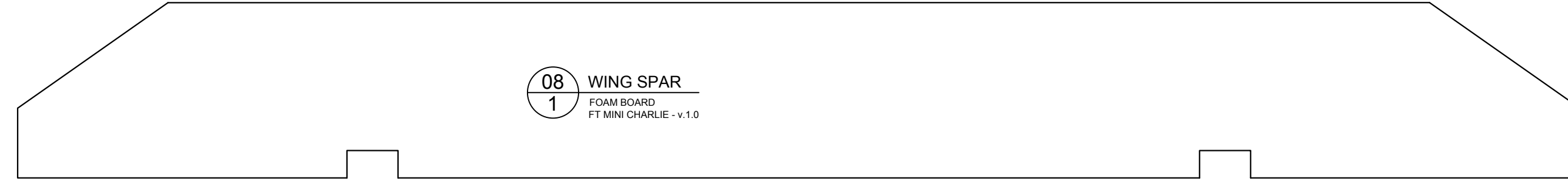

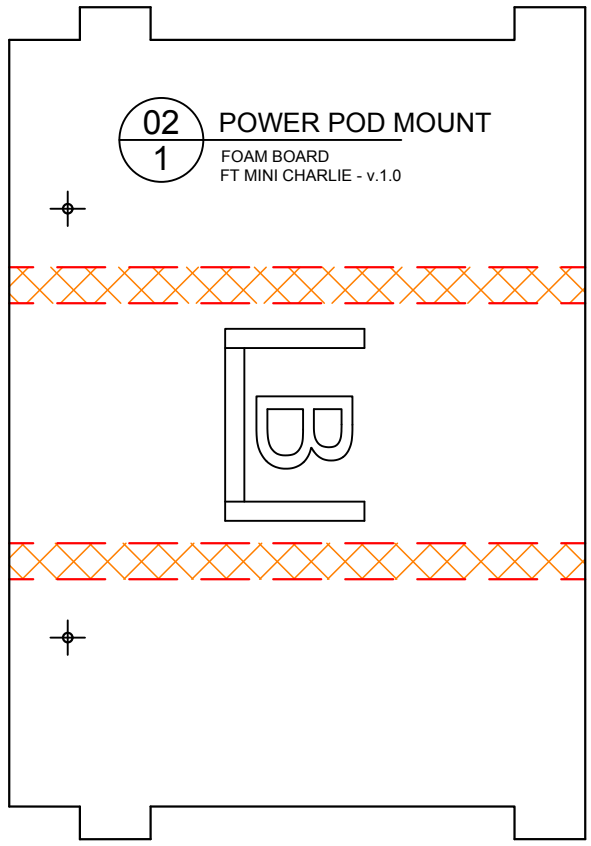
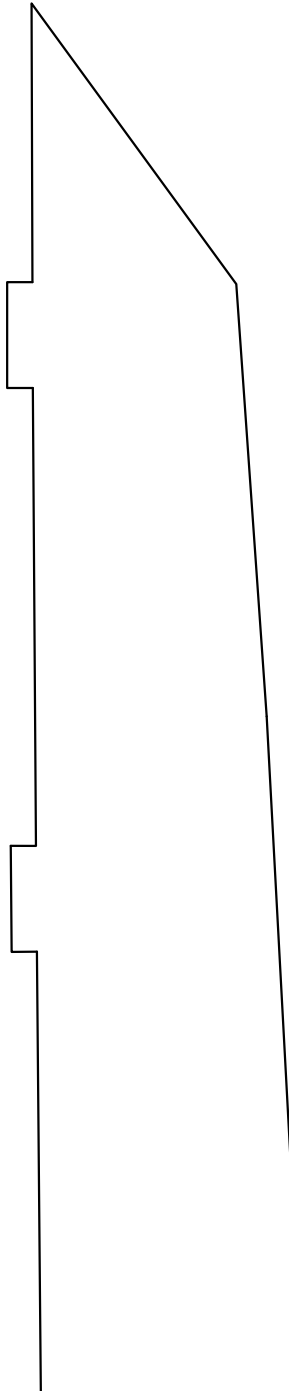

02 POWER POD MOUNT
1 FOAM BOARD
FT MINI CHARLIE - v.1.0



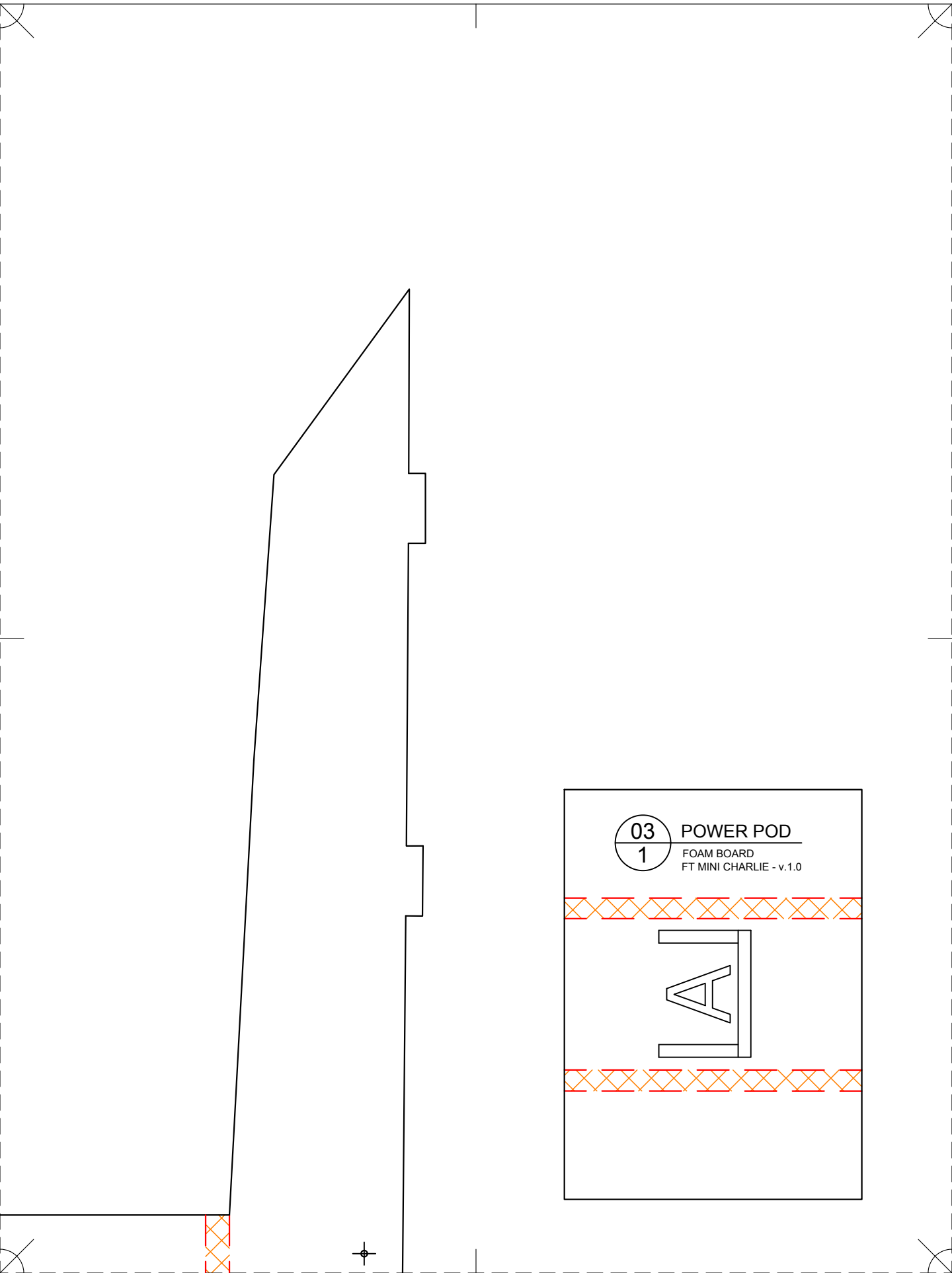

03
1

POWER POD

FOAM BOARD
FT MINI CHARLIE - v.1.0

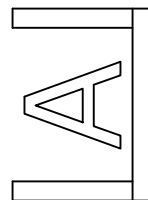

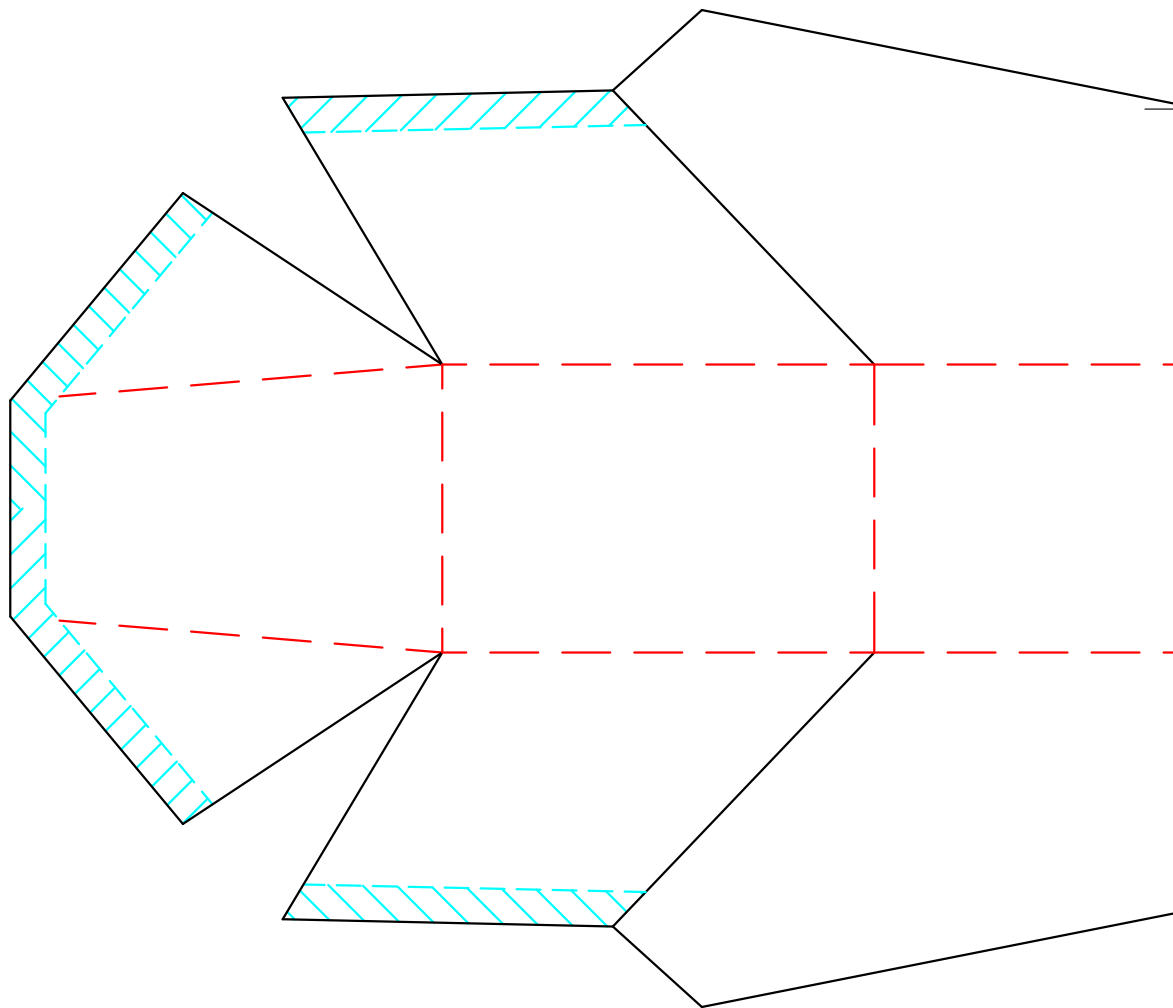
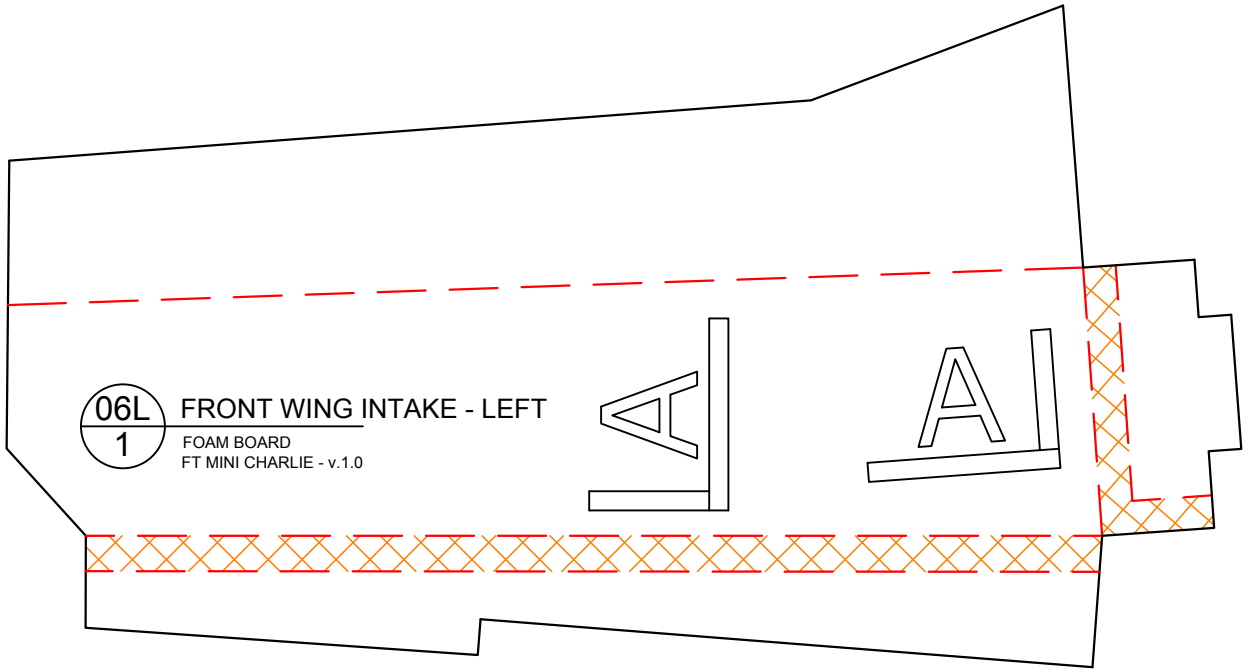

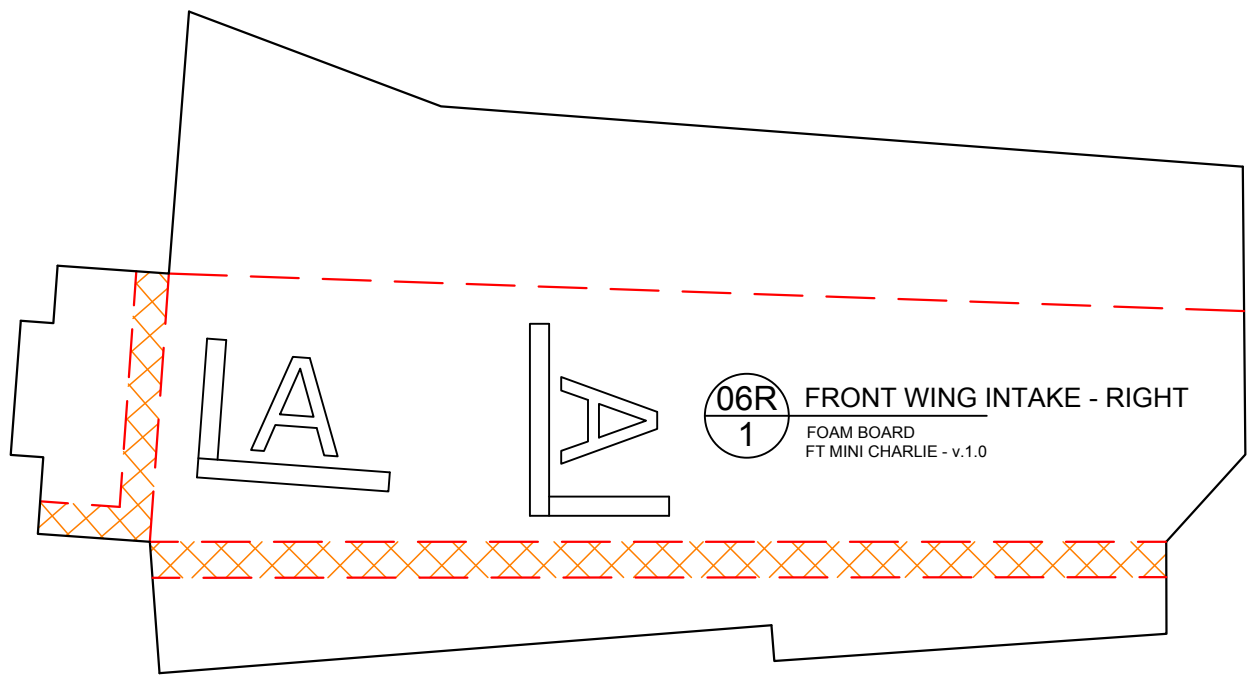

06R FRONT WING INTAKE - RIGHT
1
FOAM BOARD
FT MINI CHARLIE - v.1.0

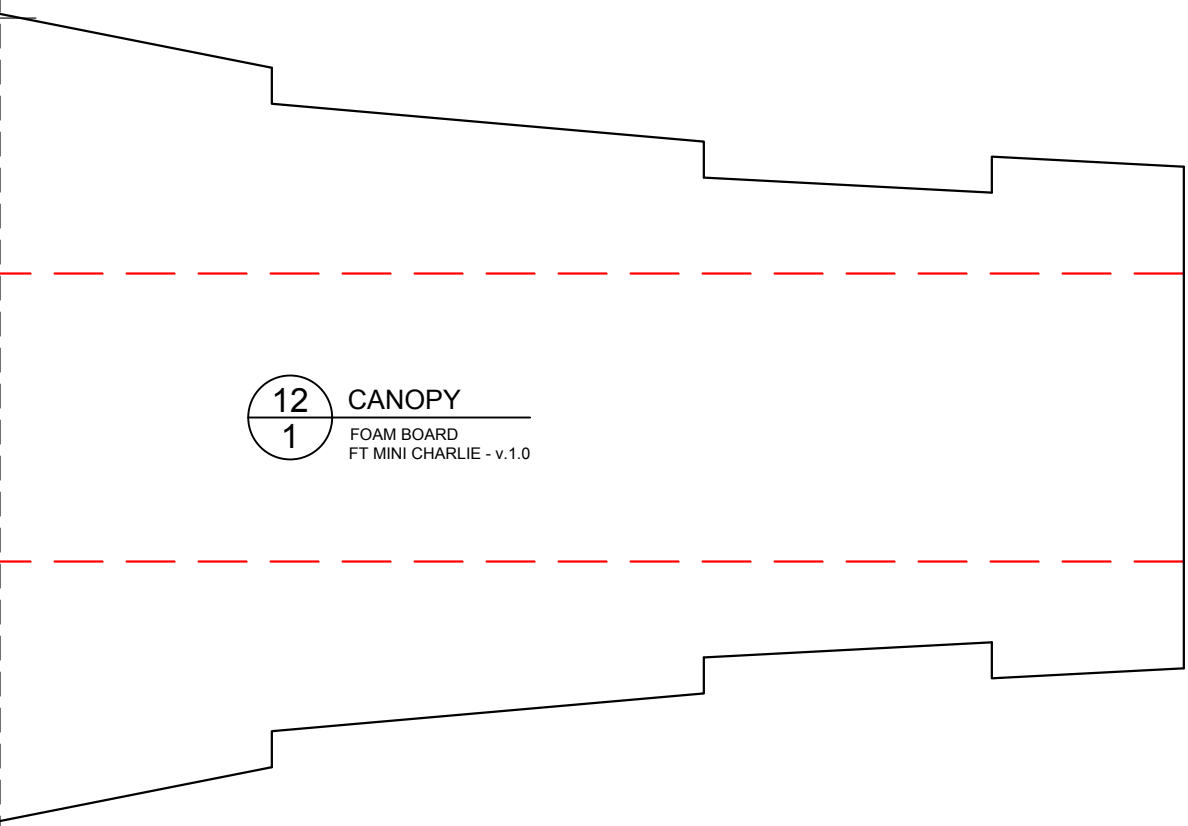

12 CANOPY
1
FOAM BOARD
FT MINI CHARLIE - v.1.0

01 BELLY PAN
FOAM BOARD
FT MINI CHARLIE - v.1.0

B

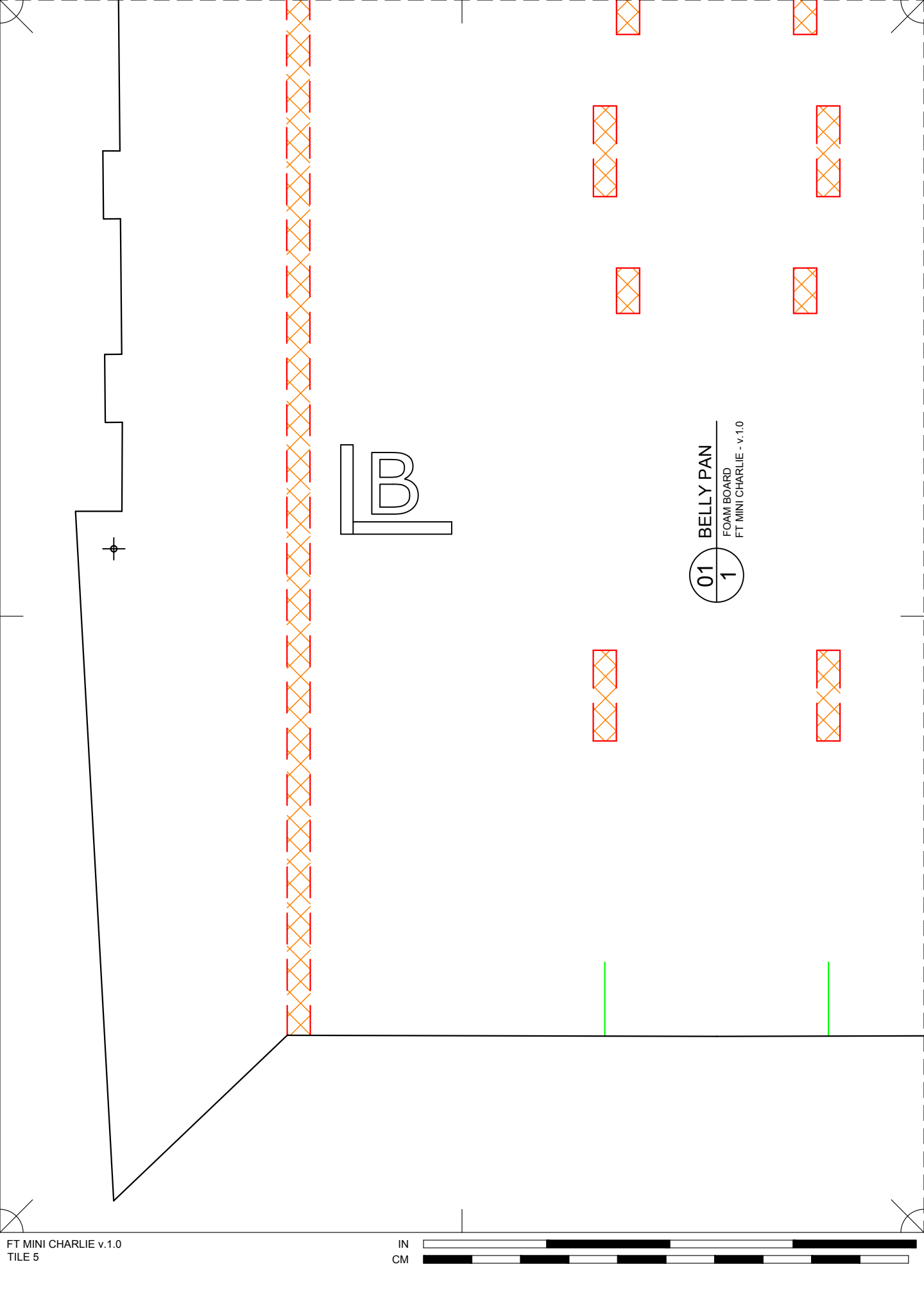

B

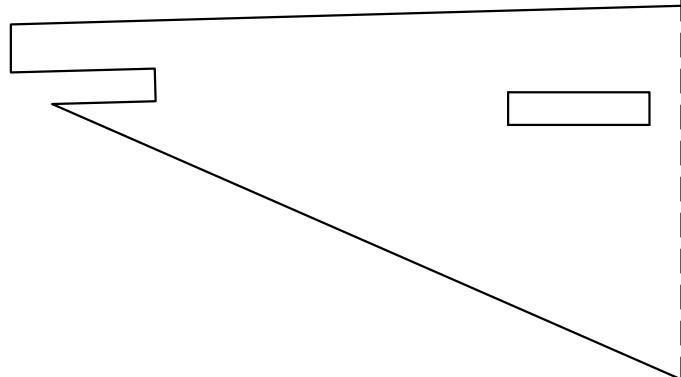
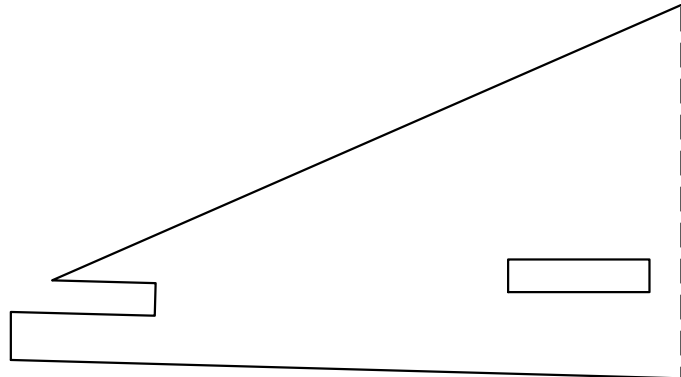

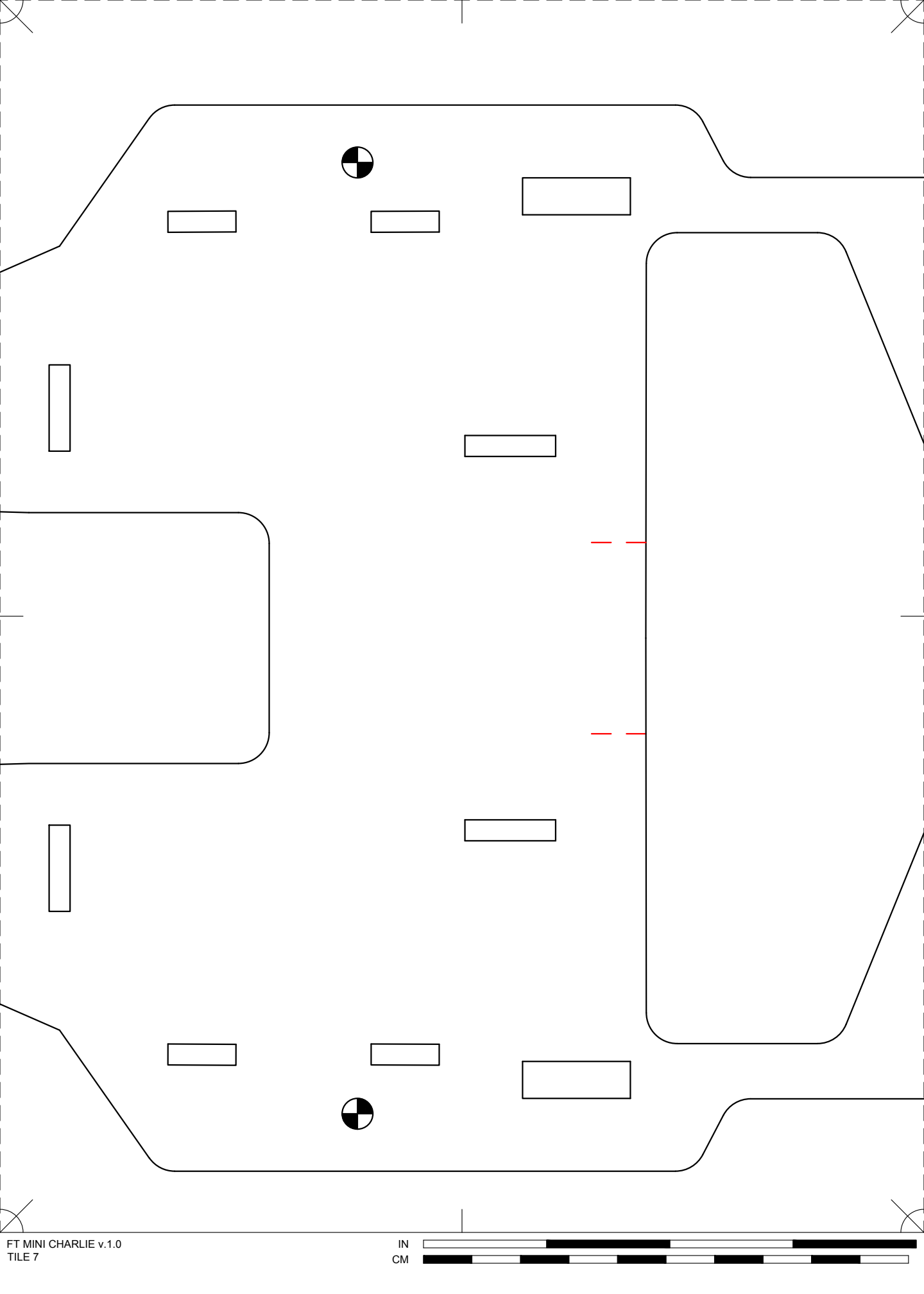

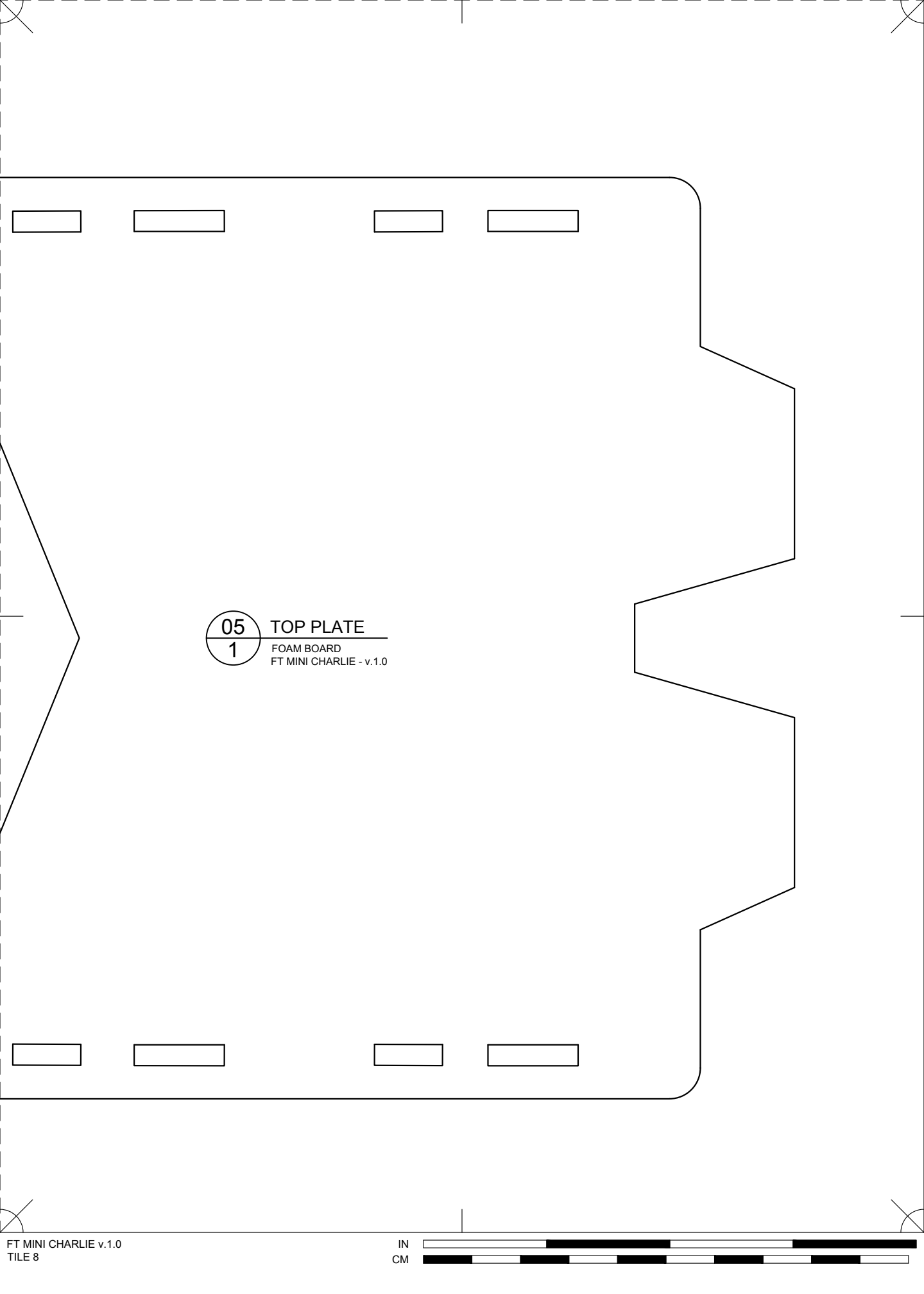

05
1

TOP PLATE
FOAM BOARD
FT MINI CHARLIE - v.1.0

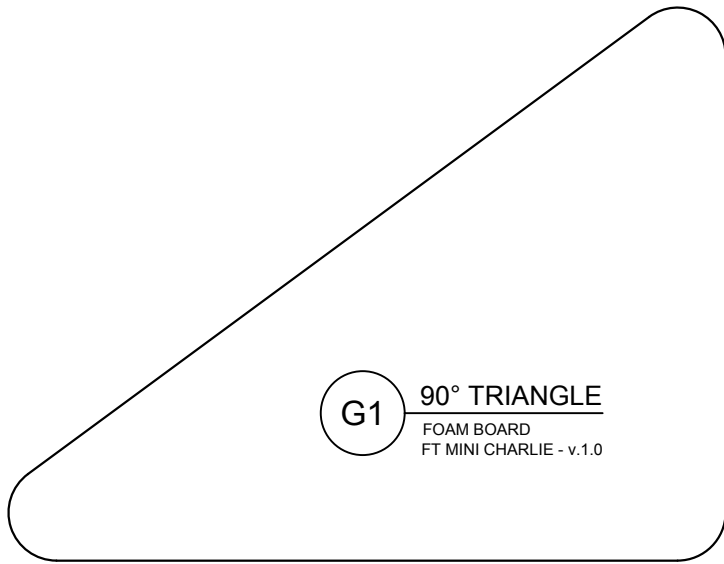

G1 90° TRIANGLE
FOAM BOARD
FT MINI CHARLIE - v.1.0

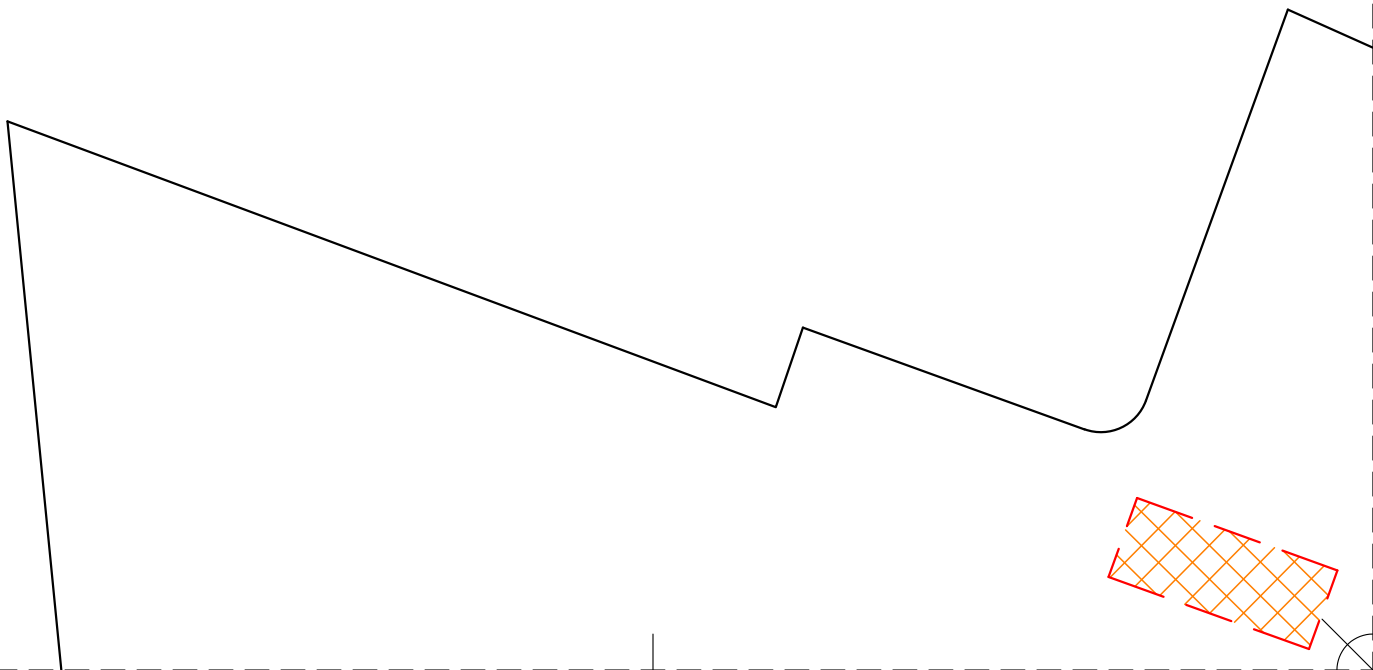

09R
1

HORIZONTAL STABILIZER - RIGHT

FOAM BOARD
FT MINI CHARLIE - v.1.0



45° SINGLE BEVEL

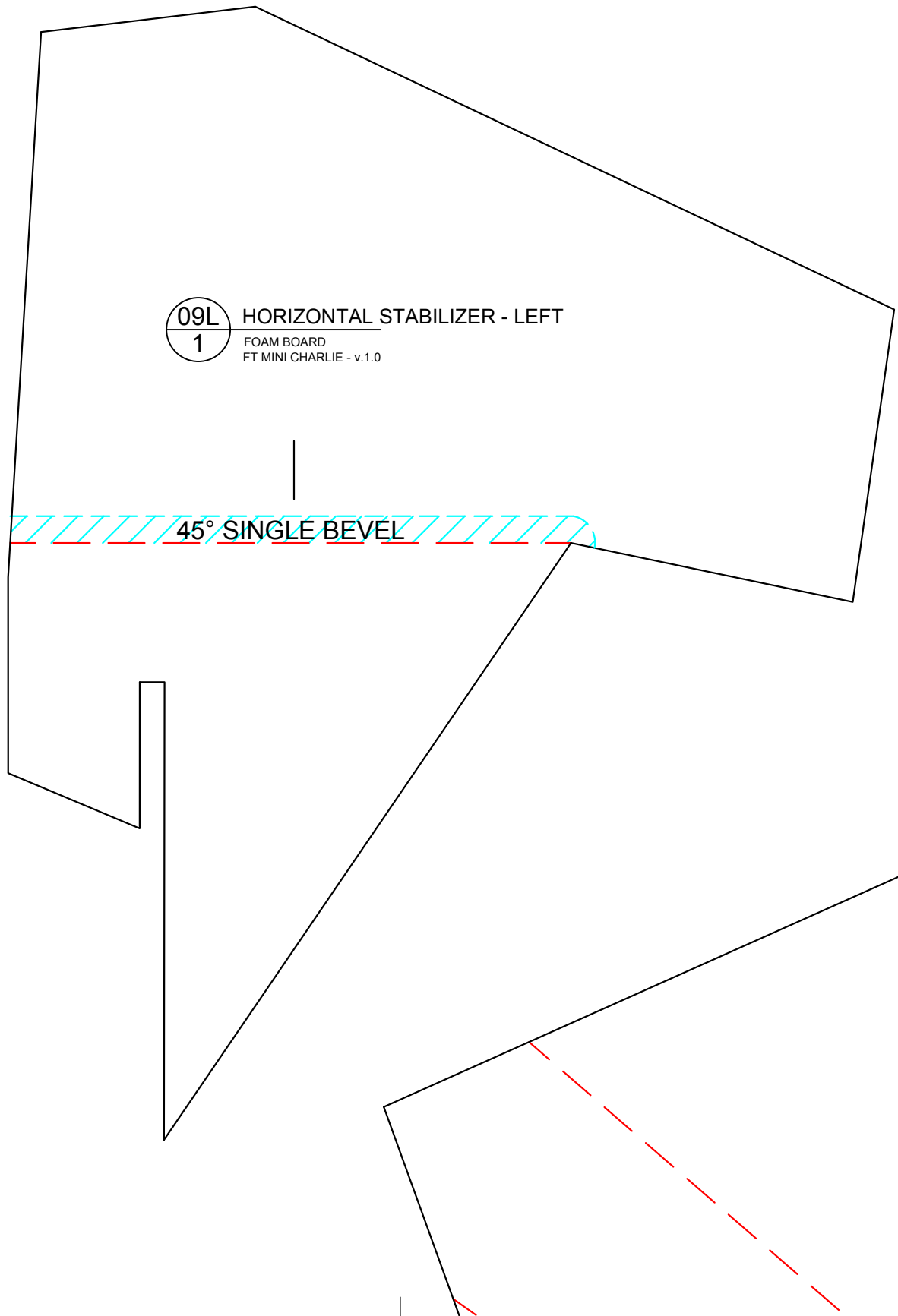

09L
1

HORIZONTAL STABILIZER - LEFT

FOAM BOARD
FT MINI CHARLIE - v.1.0

45° SINGLE BEVEL

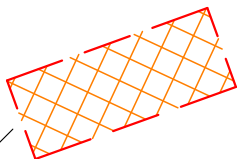
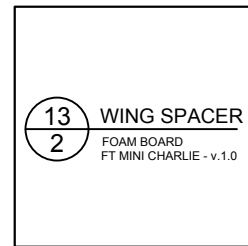
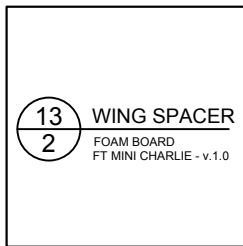

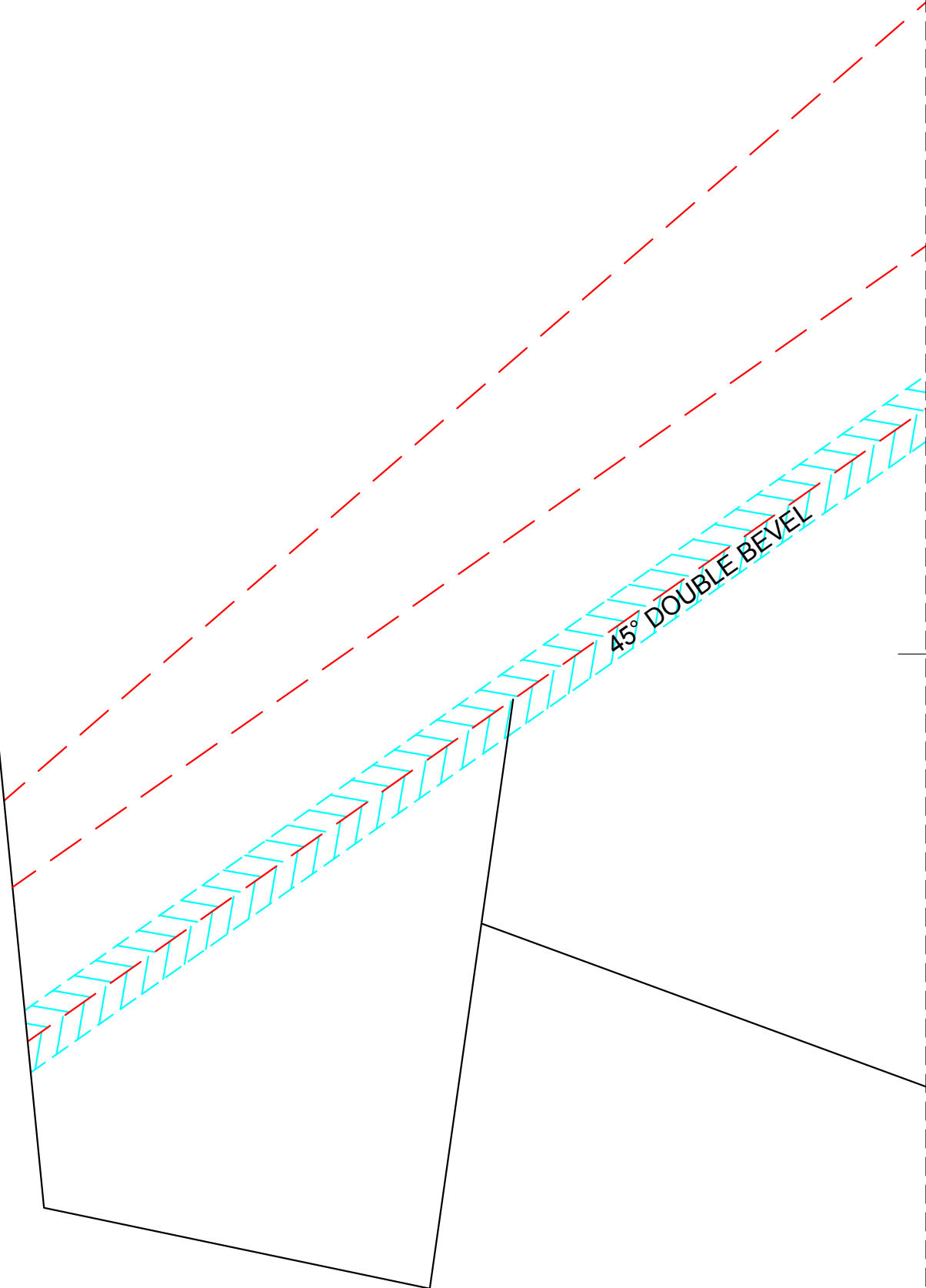

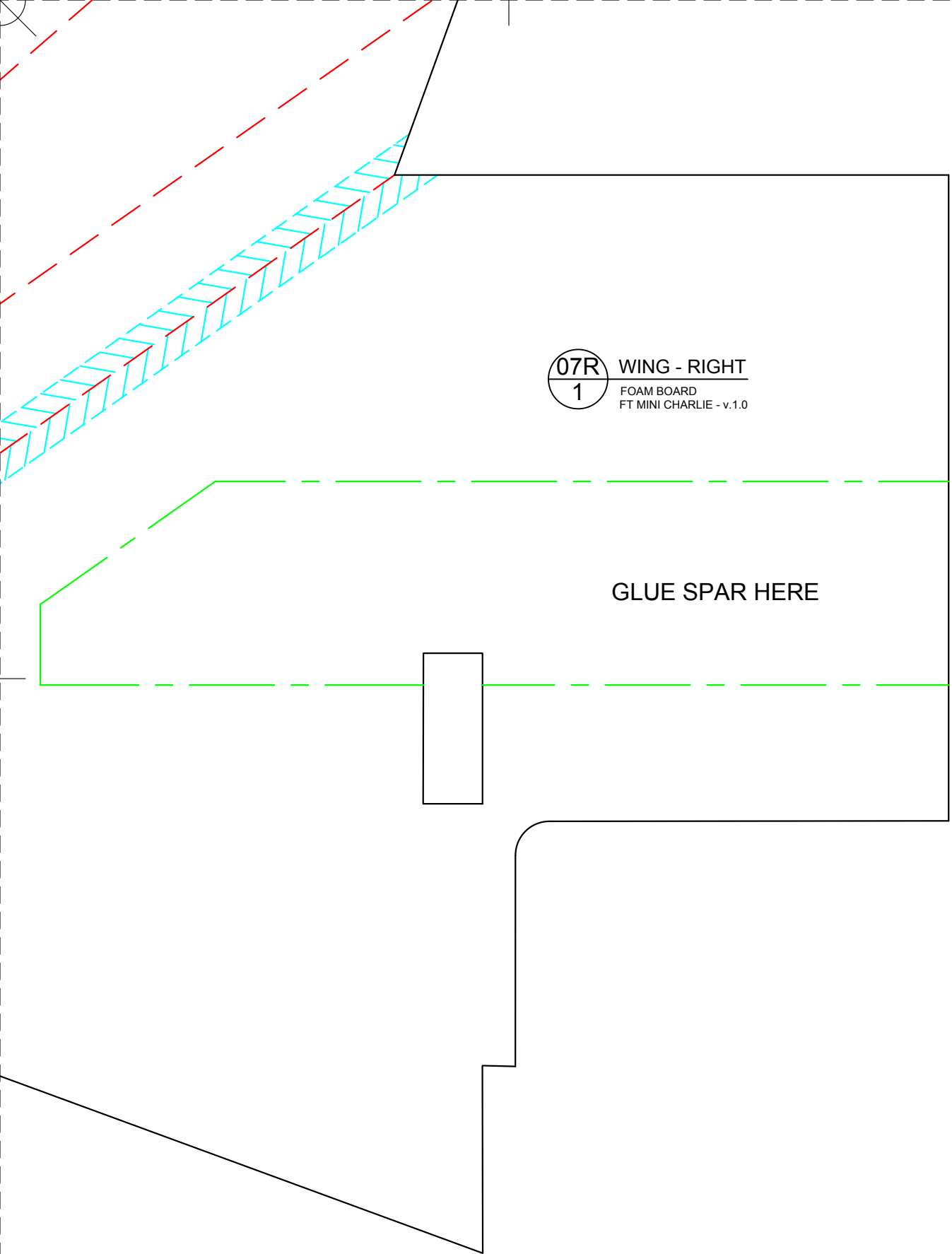

07R WING - RIGHT
1 FOAM BOARD
FT MINI CHARLIE - v.1.0

GLUE SPAR HERE

07L
1

WING - LEFT
FOAM BOARD
FT MINI CHARLIE - v.1.0

GLUE SPAR HERE

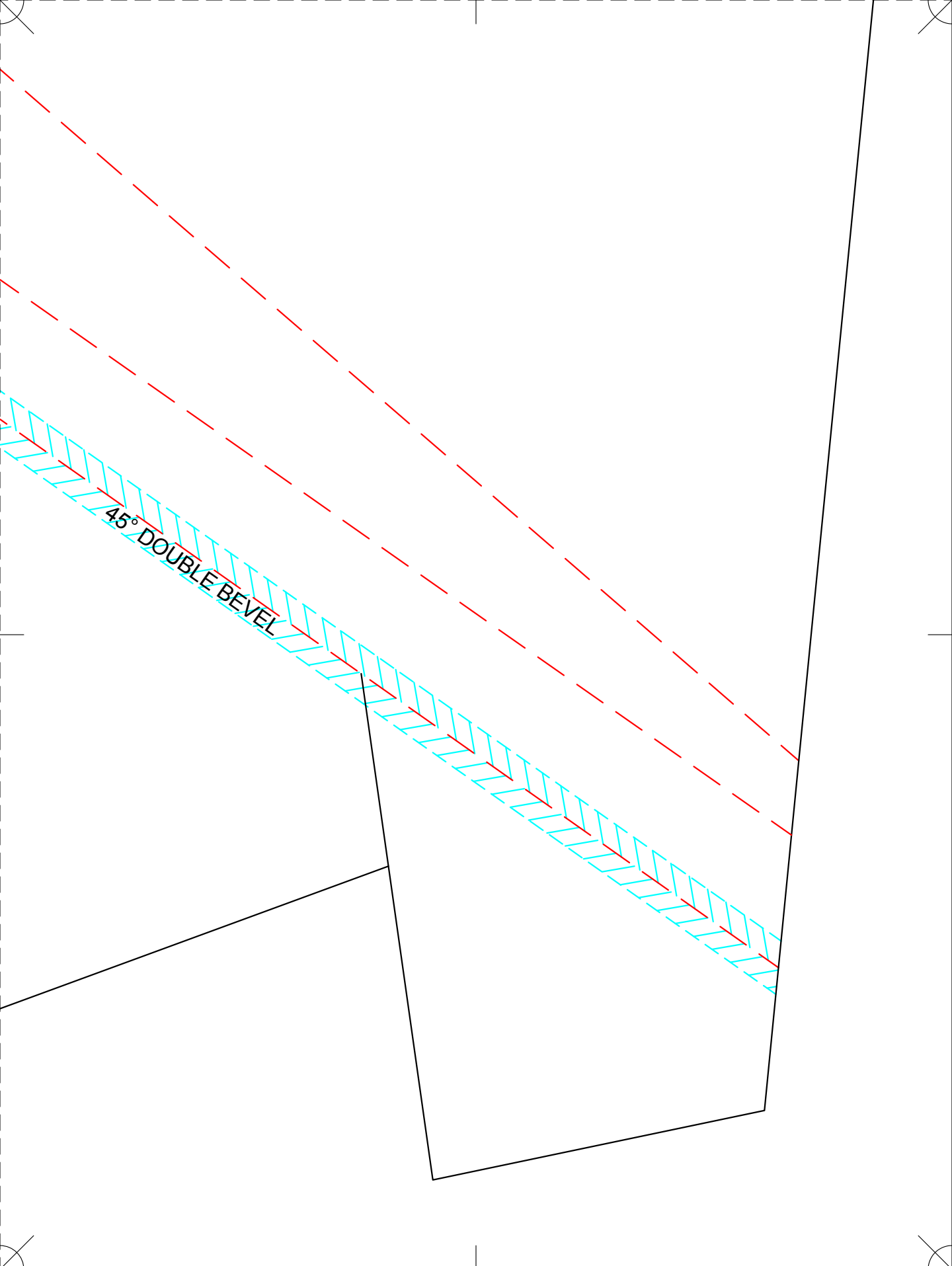

45° DOUBLE BEVEL

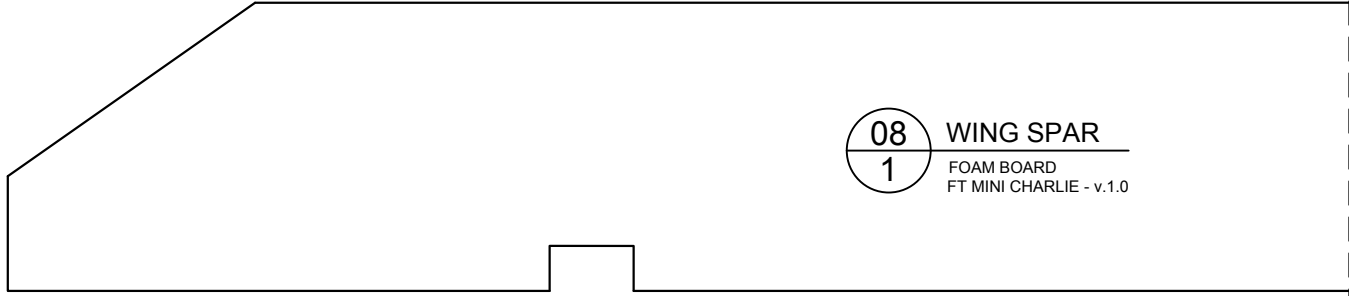

08 WING SPAR
1 FOAM BOARD
FT MINI CHARLIE - v.1.0

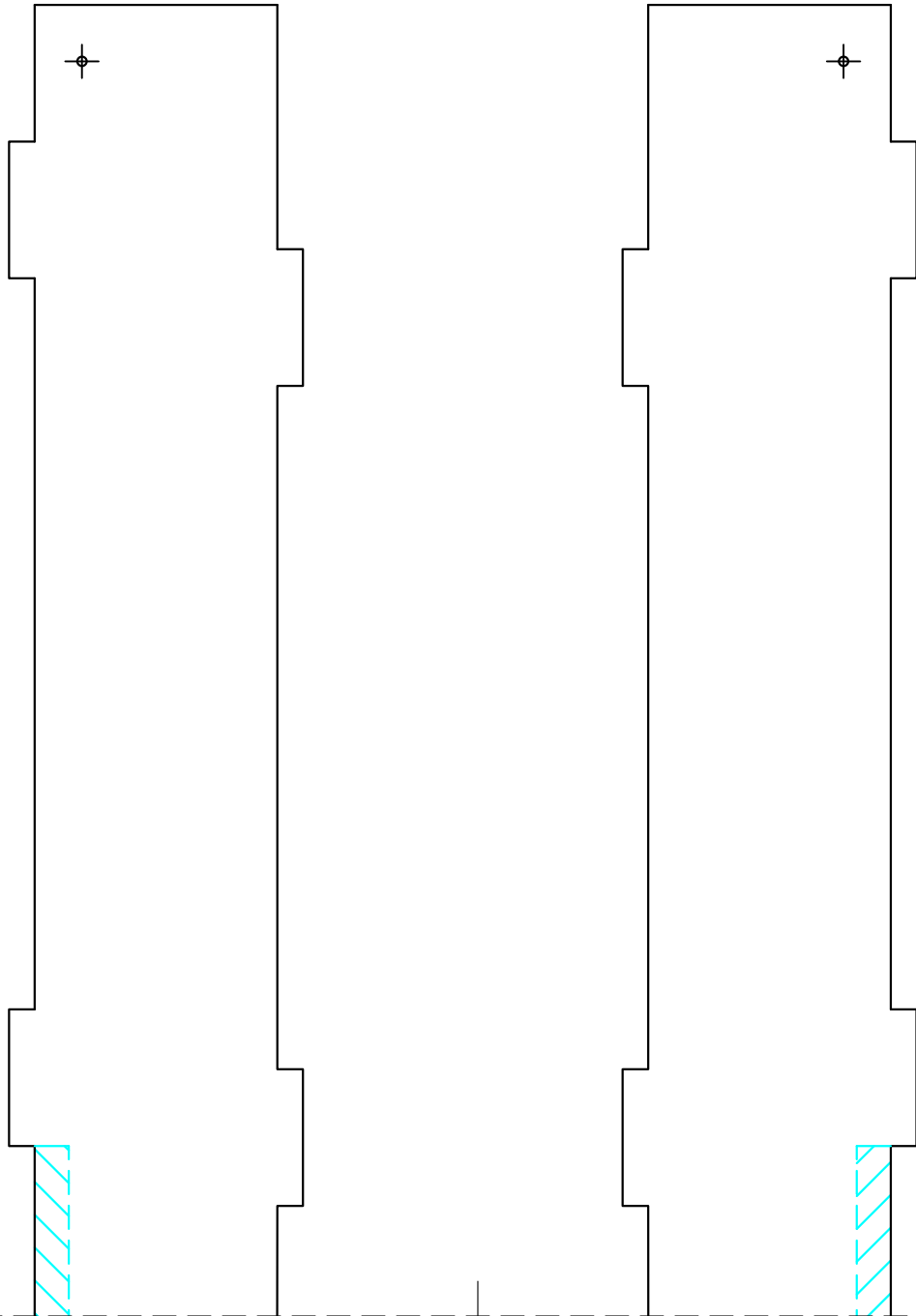

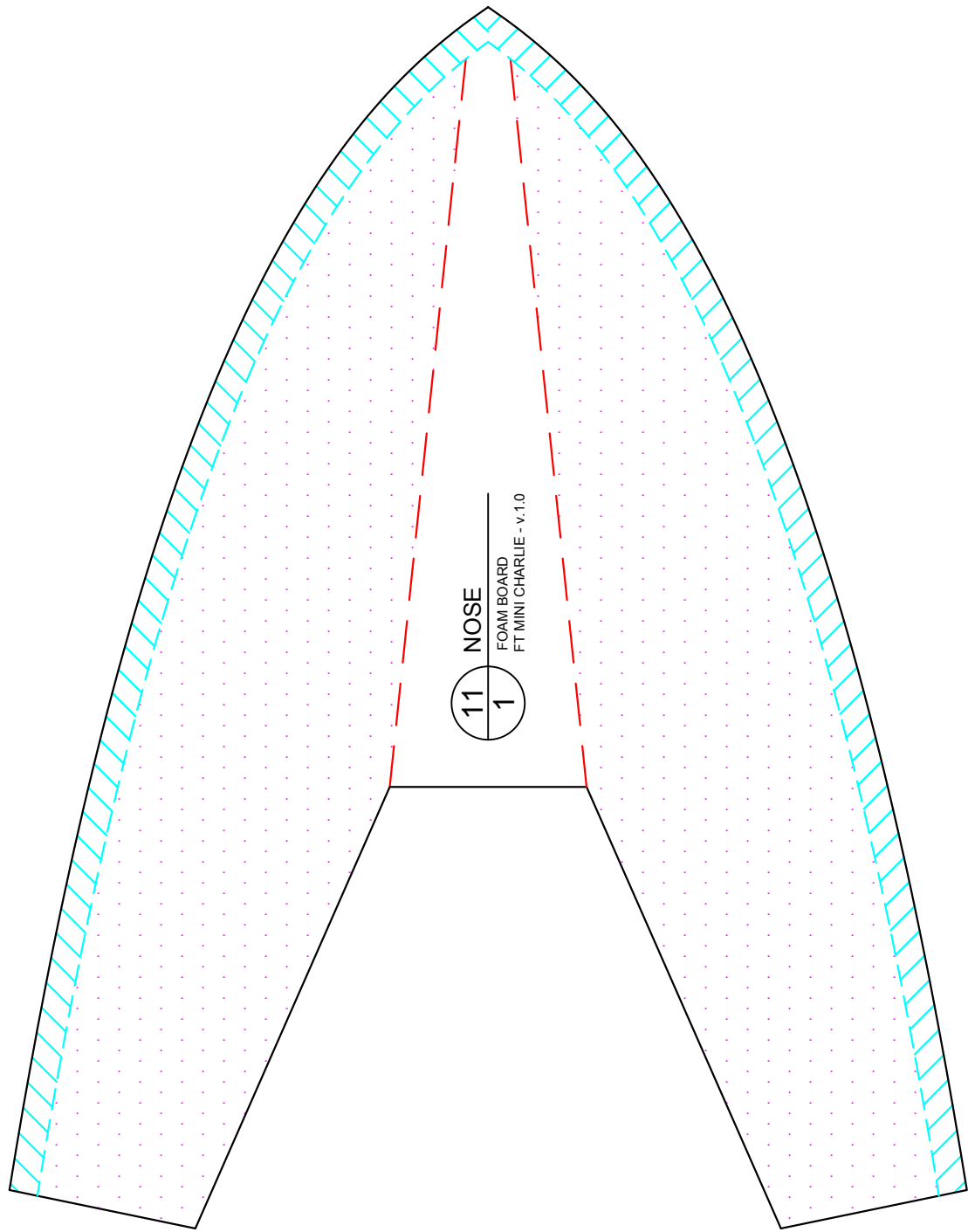
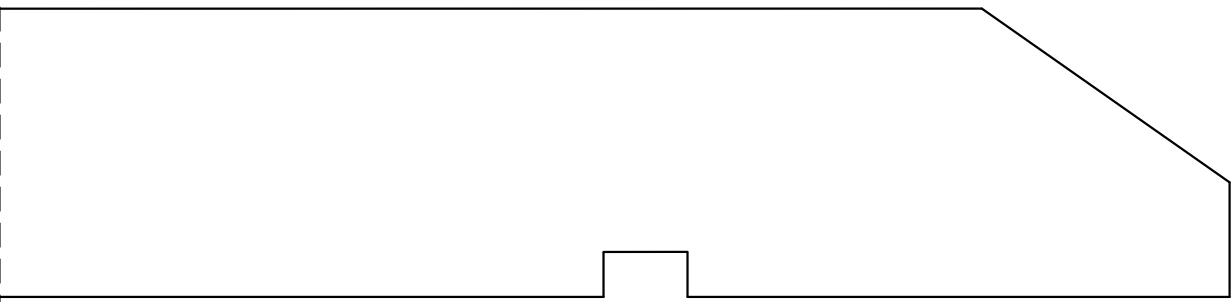

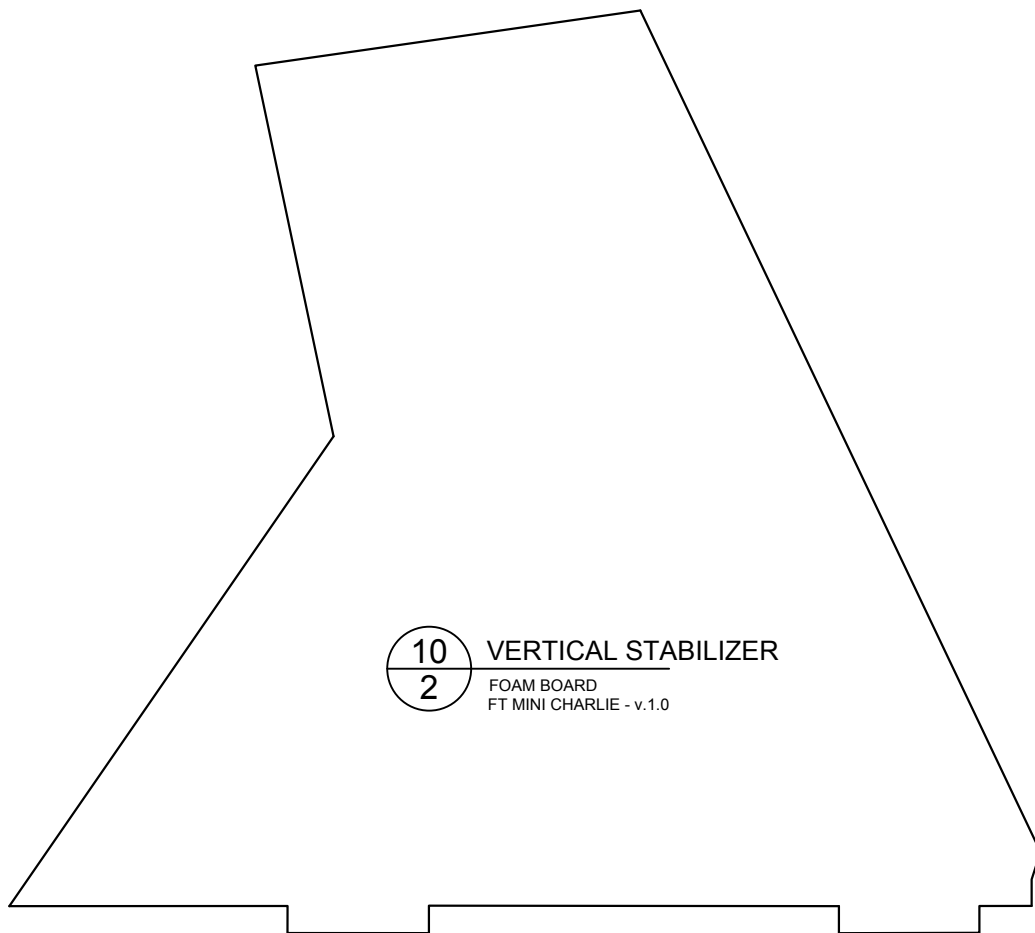

10
2

VERTICAL STABILIZER

FOAM BOARD
FT MINI CHARLIE - v.1.0

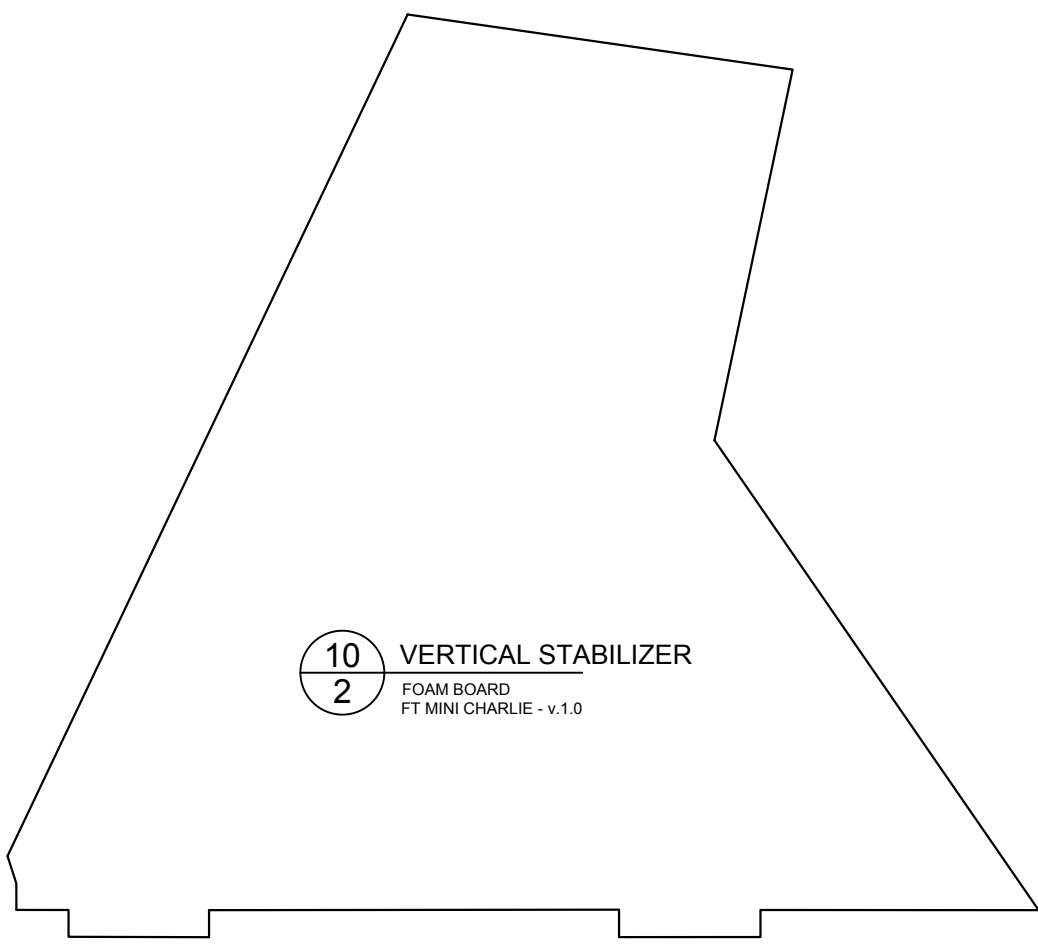

10
2

VERTICAL STABILIZER

FOAM BOARD
FT MINI CHARLIE - v.1.0

04 LOWER FUSELAGE
FOAM BOARD
FT MINI CHARLIE - v.1.0

